

Victaulic® Floor-Mounted Carbon Steel Riser Anchor



07.70

No. A10



2 – 3"/DN50 – DN80



4 – 12"/DN100 – DN300

1.0 PRODUCT DESCRIPTION

Available Sizes

- 2 – 12"/DN50 – DN300

Maximum Working Pressure

- Accommodates pressures ranging from full vacuum (29.9 in Hg) up to 500 psi/3447 kPa/34 bar

Application

- For use on carbon steel NPS riser piping¹
- An engineered pipe anchor used to assist in directing pipe movement in piping system risers that are designed and installed exclusively with Victaulic grooved products
- Exclusively for use with pipe and Victaulic products which feature the Victaulic Original Groove System (OGS) groove profile (see section 7.0 for Reference Materials)

¹ Only for use in carbon steel piping systems. For stainless steel applications, refer to [publication 17.70](#): Victaulic Floor Mounted Stainless Steel Riser Anchor: No. A10S.

2.0 CERTIFICATION/LISTINGS

Product designed and manufactured under Victaulic's Quality Management System, as certified by LPCB in accordance with ISO 9001:2018.

ALWAYS REFER TO ANY NOTIFICATIONS AT THE END OF THIS DOCUMENT REGARDING PRODUCT INSTALLATION, MAINTENANCE OR SUPPORT.

System No.		Location	
Submitted By		Date	

Spec Section		Paragraph	
Approved		Date	



3.0 SPECIFICATIONS – MATERIAL

- Standard weight carbon steel pipe conforming to ASTM A53 Grade B Type E. Roll grooved with Victaulic Original Groove System (OGS).
 - Brackets:
 - 2 – 3"/DN50 – DN80: Carbon steel conforming to ASTM A36
 - 4 – 12"/DN100 – DN300: Carbon steel conforming to ASTM A500 Grade D
 - Standard coating: Orange enamel
 - Fastening selection/method by others²
- ² Material, type, length, and capacity shall be the responsibility of others.

4.0 DIMENSIONS

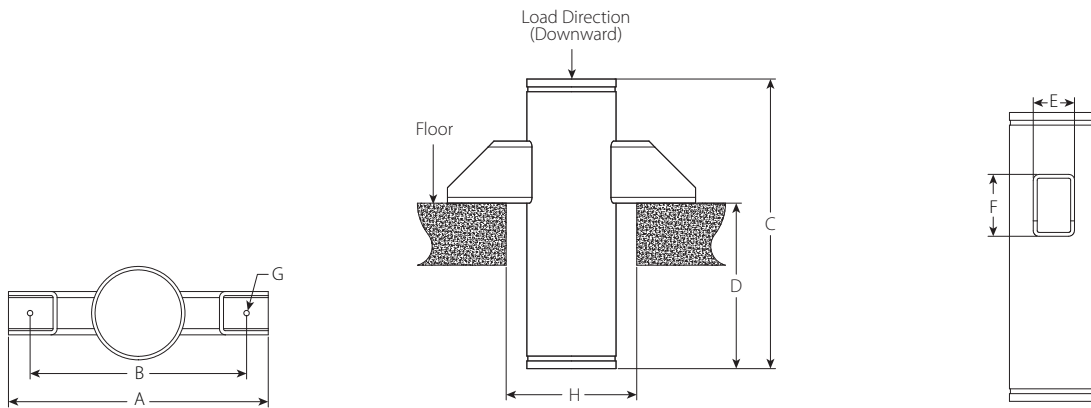

Size		Dimensions								Weight
Nominal	Actual Outside Diameter	A	B	C	D	E	F	G Bolt Hole Diameter	H Maximum Floor Hole Diameter	Approx. (Each)
inches DN	inches mm	inches mm	inches mm	inches mm	inches mm	inches mm	inches mm	inches mm	inches mm	lbs kg
2	2.375	14.00	12.00	24.00	16.00	2.00	3.00	0.625	6.375	10.0
DN50	60.3	356	305	610	406	51	76	15.9	161.9	4.5
2 ½	2.875	14.00	12.00	24.00	16.00	2.00	3.00	0.625	6.875	14.0
	73.0	356	305	610	406	51	76	15.9	174.6	6.5
3	3.500	16.00	14.00	24.00	16.00	2.00	3.00	0.625	7.500	17.0
DN80	88.9	406	356	610	406	51	76	15.9	190.5	7.5
4	4.500	16.00	14.00	24.00	16.00	2.00	4.00	0.625	8.500	30.0
DN100	114.3	406	356	610	406	51	102	15.9	215.9	14.0
5	5.563	18.00	16.00	24.00	16.00	2.00	4.00	0.625	9.963	42.0
	141.3	457	406	610	406	51	102	15.9	253.1	19.1
6	6.625	21.00	18.00	28.00	16.00	4.00	6.00	0.875	10.625	68.0
DN150	168.3	533	457	711	406	102	152	22.2	269.9	30.8
8	8.625	23.00	20.00	28.00	16.00	4.00	6.00	0.875	12.625	90.0
DN200	219.1	584	508	711	406	102	152	22.2	320.7	40.8
10	10.750	27.00	24.00	30.00	16.00	4.00	6.00	0.875	14.750	135.0
DN250	273.0	686	610	762	406	102	152	22.2	374.7	61.2
12	12.750	31.00	28.00	30.00	16.00	4.00	6.00	0.875	16.750	152.0
DN300	323.9	787	711	762	406	102	152	22.2	425.5	69.0







5.0 PERFORMANCE

Size		Maximum Working Pressure	Maximum Anchor Load ^{3-5, 7} Downward	Maximum Anchor Load ³⁻⁷ Upward
Nominal inches DN	Actual Outside Diameter inches mm			
2 DN50	2.375 60.3	500 3445	3500 15500	700 3114
2 ½	2.875 73.0	500 3445	5000 22200	1000 4448
3 DN80	3.500 88.9	500 3445	6500 28900	1200 5338
4 DN100	4.500 114.3	500 3445	10000 44400	2000 8896
5	5.563 141.3	500 3445	15000 66700	3000 13345
6 DN150	6.625 168.3	500 3445	20000 88900	4000 17793
8 DN200	8.625 219.1	500 3445	30000 133400	6000 26689
10 DN250	10.750 273.0	500 3445	35000 155600	7000 31138
12 DN300	12.750 323.9	500 3445	40000 177900	8000 35586

- ³ Engineer of Record and/or structural engineer are responsible to verify that the attachment method and supporting structure are structurally adequate to withstand the above noted Maximum Anchor Loads. For bolted applications, all reaction forces on the bolts shall be accounted for, including, but not limited to, tensile loads that result from downward loading as a result of bracket reacting with the structure, and tensile loads resulting from upward loading.
- ⁴ Anchor is only designed for loading in the axial directions of the pipe, vertically upwards or downwards. Any lateral loading must be negated by the owner/ engineer by the use of guides or other methods to ensure only vertical, axial loading is transmitted to the anchor.
- ⁵ For applications with maximum anchor loads greater than listed above, please contact Victaulic.
- ⁶ Acceptable methods of attachment include bolting or welding of the brackets to the structure. Chosen method is the responsibility of others.
- ⁷ Maximum Anchor Load shall be the lesser of the value shown and the published Maximum End Load for the coupling selected to join the Anchor to the adjoining piping system.

6.0 NOTIFICATIONS

⚠ WARNING

- Read and understand all instructions before attempting to install, remove, adjust, or maintain any Victaulic piping products
- Depressurize and drain the piping system before attempting to install, remove, adjust, or maintain any Victaulic piping products
- Wear safety glasses, hardhat, and foot protection

Failure to follow these instructions could result in death or serious personal injury and property damage.

7.0 REFERENCE MATERIALS

[06.02: Victaulic Zero-Flex Rigid Coupling: Style 07](#)

[06.04: Victaulic Standard Flexible Coupling: Style 77](#)

[06.23: Victaulic QuickVic™ Rigid Coupling: Style 107N](#)

[06.24: Victaulic QuickVic™ Flexible Coupling: Style 177N](#)

[I-100: Victaulic Field Installation Handbook](#)

[I-107N: Victaulic Installation Instructions: Style 107N QuickVic™ Installation-Ready™ Rigid Coupling](#)

[I-177N: Victaulic Installation Instructions: Style 177N QuickVic™ Installation-Ready™ Flexible Coupling](#)

[I-A10/A10S: Victaulic Installation Instructions: Nos. A10 and A10S Floor-Mounted Riser Anchors](#)

User Responsibility for Product Selection and Suitability

Each user bears final responsibility for making a determination as to the suitability of Victaulic products for a particular end-use application, in accordance with industry standards and project specifications, as well as Victaulic performance, maintenance, safety, and warning instructions. Nothing in this or any other document, nor any verbal recommendation, advice, or opinion from any Victaulic employee, shall be deemed to alter, vary, supersede, or waive any provision of Victaulic Company's standard conditions of sale, installation guide, or this disclaimer.

Intellectual Property Rights

No statement contained herein concerning a possible or suggested use of any material, product, service, or design is intended, or should be construed, to grant any license under any patent or other intellectual property right of Victaulic or any of its subsidiaries or affiliates covering such use or design, or as a recommendation for the use of such material, product, service, or design in the infringement of any patent or other intellectual property right. The terms "Patented" or "Patent Pending" refer to design or utility patents or patent applications for articles and/or methods of use in the United States and/or other countries.

Note

This product shall be manufactured by Victaulic or to Victaulic specifications. All products to be installed in accordance with current Victaulic installation/assembly instructions. Victaulic reserves the right to change product specifications, designs and standard equipment without notice and without incurring obligations.

Installation

Reference should always be made to the Victaulic installation handbook or installation instructions of the product you are installing. Handbooks are included with each shipment of Victaulic products, providing complete installation and assembly data, and are available in PDF format on our website at www.victaulic.com.

Warranty

Refer to the Warranty section of the current Price List or contact Victaulic for details.

Trademarks

Victaulic and all other Victaulic marks are the trademarks or registered trademarks of Victaulic Company, and/or its affiliated entities, in the U.S. and/or other countries.