

Victaulic® VicFlex™ Sprinkler Fittings

Series AQC-U Braided Flexible Hose Assemblies for Clean Room Ceilings

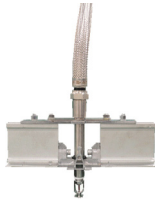

1.0 PRODUCT DESCRIPTION

Available Sizes by Component

- **Series AQC-U Assembly Hose:** 36, 48, 72"/914, 1219, 1830 mm.
- **Brackets:** Swivel bracket integrated in Series AQC-U assembly

Maximum Working Pressure

- 200 psi/1400 kPa/14 bar

Maximum Working Temperature

- 225°F/107°C

Connections:

- To branch line (inlet) via 1"/25.4 mm NPT or BSPT male thread
- To sprinkler head (outlet) via ½"/15 mm NPT or BSPT female thread

Minimum Bend Radius

- 6"/152 mm

Maximum Number of Bends per Flexible Drop:

- See section 5.0 Performance.

Application

FM approved for use with the following manufacturer's ceiling types:

- M+W Zander Facility Engineering GmbH.

NOTE

- Other cleanroom ceiling manufacturers can be evaluated and potentially approved on a case-by-case basis. For further assistance, please refer to the form in Section 7.0 Reference Materials.

ALWAYS REFER TO ANY NOTIFICATIONS AT THE END OF THIS DOCUMENT REGARDING PRODUCT INSTALLATION, MAINTENANCE OR SUPPORT.

System No.		Location	
Submitted By		Date	

Spec Section		Paragraph	
Approved		Date	

2.0 CERTIFICATION/LISTINGS



3.0 MATERIAL SPECIFICATIONS

Reducer: 300-series stainless steel

Ceiling Gasket Seal: EPDM

Connection Nut: Zinc plated carbon steel

Isolation Ring: Nylon

Branch Line Connection: Zinc plated carbon steel

Braid and Collar: 300-series stainless steel

Swivel Bracket: 300-series Stainless Steel

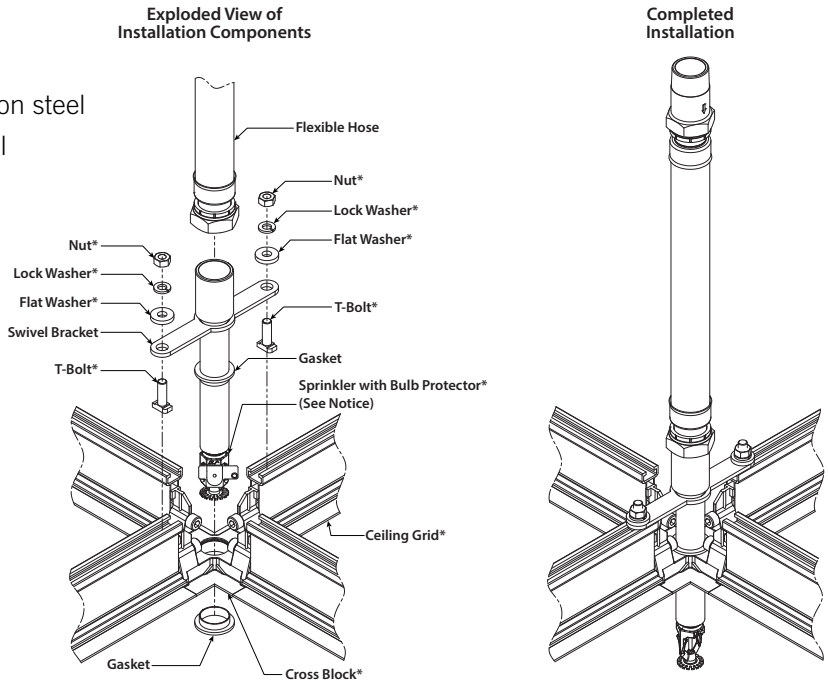

* Denotes components that Victaulic does not provide but that are provided with the ceiling grid

4.0 DIMENSIONS

AQC-U for use with M+W Zander Facility Engineering GmbH ceiling.

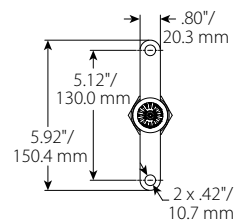
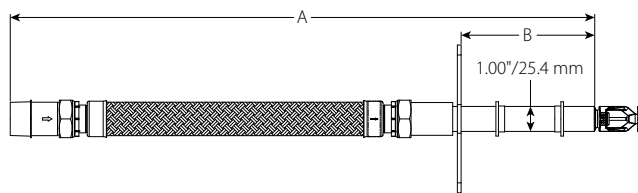

NOTE

- To specify alternative dimensions please use order form in section 7.0 Reference Materials.

"A" Nominal Length of Flexible Hose inches mm	"B" Length from Swivel Bracket to Sprinkler ¹ inches mm
36 914	5.38 137
48 1219	5.38 137
72 1830	5.38 137

¹ To specify alternative "B" length use order form in section 7.0 Reference Materials.







5.0 PERFORMANCE

FM Friction Loss Data - Series AQC-U Assembly for Clean Room Ceilings

Nominal Length of Flexible Hose inches mm	NPT/BSPT Sprinkler End inches mm	Maximum Number of 90° Bends	Equivalent Length of 1"/33.7 mm Schedule 40 Pipe feet meters
36 900	½ 15	2	24 7.3
48 1200	½ 15	3	31.5 9.6
72 1800	½ 15	4	46.6 14.2

6.0 NOTIFICATIONS

⚠ WARNING







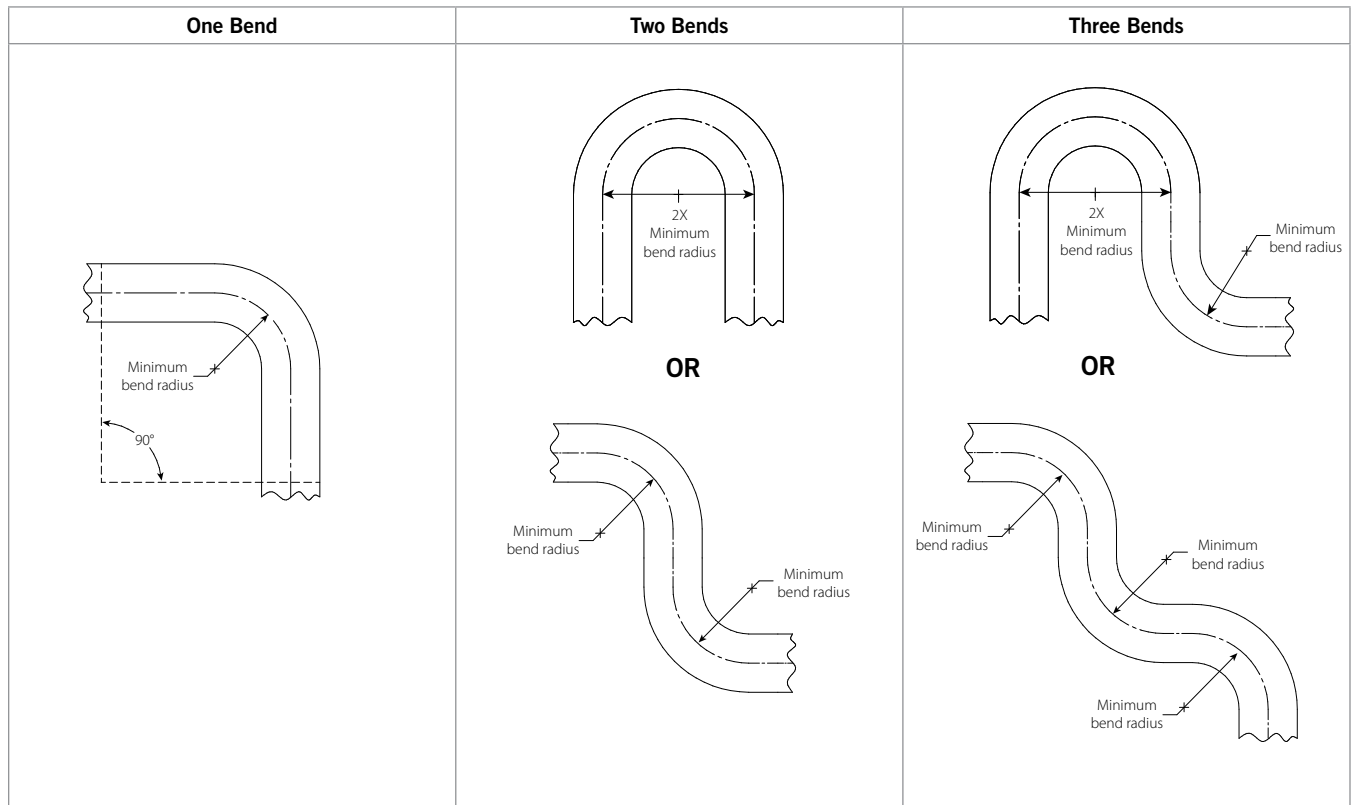

- Read and understand all instructions before attempting to install, remove, adjust, or maintain any Victaulic piping products.
- Depressurize and drain the piping system before attempting to install, remove, adjust, or maintain any Victaulic piping products.
- Wear safety glasses, hardhat, foot protection, and hearing protection.

Failure to follow these instructions and warnings could cause system failure, resulting in death or serious personal injury and property damage.

7.0 REFERENCE MATERIALS

Flexible Hose In-Plane Bend



NOTE

- For out-of-plane (three-dimensional) bends, care must be taken to avoid imparting torque on the hose.

7.0 REFERENCE MATERIALS (Continued)

VicFlex™ Series AQC-U Flexible Sprinkler Fitting Assembly for Clean Rooms Form

For ceiling grids incompatible with the standard dimensions stated in section 4.0 Dimensions, please fill out the form below to request a quote and either email or fax to Engineered Products – ep@victaulic.com, 610-923-3010.

Company Name	
Company Location	
Contact Name	
Contact Phone	
Contact Email	
Project Name	
End User Name	

Quantity

If different configurations are required, please attach a separate form for each configuration.

Step 1: Specify Ceiling Manufacturer

Step 2: Select Assembly Type

No sprinkler pre-assembled.

Assembly with sprinkler pre-assembled.

Step 3: Select and specify values in table below for each configuration as required.

Select One Each:

A	Total Nominal Hose Assembly Length	36"/914mm	48"/1219mm	72"/1830mm
I	Inlet Thread	1"/25mm NPT	1"/25mm BSPT	
O	Outlet Thread	½"/15mm NPT	½"/15mm BSPT	

Specify: Swivel Bracket Dimensions

B	
C	
D	
E	
F	

Optional (Please Select):

V27 pendent model (SIN)	
Temperature Rating	
Finish	

Please reference the following submittals for Sprinkler information
40.10, 40.17, 40.18, 40.40

NOTE

- Specified systems DO NOT include escutcheon plates.
- These items must be ordered separately from Victaulic.
- See current Victaulic Sprinkler Price List or contact Customer Care.

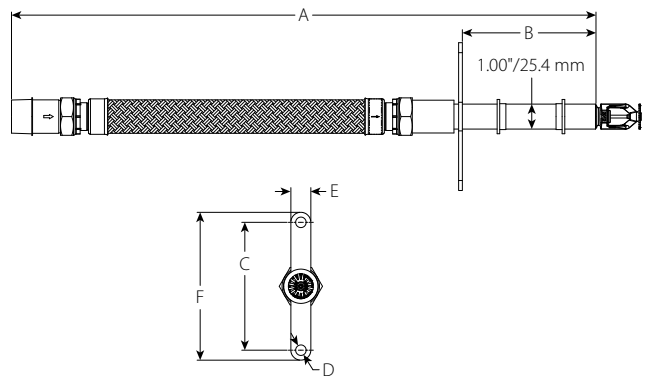

NOTE

- Please provide swivel bracket dimensions in accordance with different ceilings.

User Responsibility for Product Selection and Suitability

Each user bears final responsibility for making a determination as to the suitability of Victaulic products for a particular end-use application, in accordance with industry standards and project specifications, and the applicable building codes and related regulations as well as Victaulic performance, maintenance, safety, and warning instructions. Nothing in this or any other document, nor any verbal recommendation, advice, or opinion from any Victaulic employee, shall be deemed to alter, vary, supersede, or waive any provision of Victaulic Company's standard conditions of sale, installation guide, or this disclaimer.

Intellectual Property Rights

No statement contained herein concerning a possible or suggested use of any material, product, service, or design is intended, or should be constructed, to grant any license under any patent or other intellectual property right of Victaulic or any of its subsidiaries or affiliates covering such use or design, or as a recommendation for the use of such material, product, service, or design in the infringement of any patent or other intellectual property right. The terms "Patented" or "Patent Pending" refer to design or utility patents or patent applications for articles and/or methods of use in the United States and/or other countries.

Note

This product shall be manufactured by Victaulic or to Victaulic specifications. All products to be installed in accordance with current Victaulic installation/assembly instructions. Victaulic reserves the right to change product specifications, designs and standard equipment without notice and without incurring obligations.

Installation

Reference should always be made to the Victaulic installation handbook or installation instructions of the product you are installing. Handbooks are included with each shipment of Victaulic products, providing complete installation and assembly data, and are available in PDF format on our website at www.victaulic.com.

Warranty

Refer to the Warranty section of the current Price List or contact Victaulic for details.

Trademarks

Victaulic and all other Victaulic marks are the trademarks or registered trademarks of Victaulic Company, and/or its affiliated entities, in the U.S. and/or other countries.