

Series W709 AGS Butterfly Valves

150 psi/1035 kPa

The Series W709 AGS (Advanced Groove System) grooved end butterfly valve offers an easily installed choice to cumbersome, multi-bolt wafer, lug-type or flanged valves. The valve has excellent flow characteristics with low torque operation. The resilient EPDM seat is rated for water services up to +180°F/+82°C.

The offset disc is ductile iron with a fusion bonded epoxy coating for corrosion resistance. A stainless steel seat retainer securely retains the resilient seat for bi-directional working pressure to 150 psi/1035 kPa.

The single piece body is cast of durable ductile iron (ASTM A-536, grade 65-45-12), as is the narrow profile disc. The valve is cast with lifting lugs for installation and handling. The disc rides on stout stainless steel upper and lower stems with all other wetted hardware of stainless steel or aluminum bronze construction.

Series W709 AGS butterfly valves 26 - 48"/650 - 1200 mm are available with a handwheel gear operator. Chain wheels are available options, as are electric, pneumatic or hydraulic actuators.

Series W709 AGS valves are designed for direct connection with Victaulic AGS grooved couplings. Request publication 20.02 for W07 AGS rigid or 20.03 for W77 AGS flexible coupling information.



WARNING

WARNING

- Victaulic AGS products use a patent-pending groove profile that requires the use of special AGS rolls. AGS products must not be used on pipe that has been grooved using standard grooving rolls.

Failure to use AGS products on AGS grooved pipe could result in serious personal injury, property damage, joint leakage or joint separation.

NOTICE

- DO NOT install valves with the disc in the full-open position. Make sure no part of the disc protrudes beyond the end of the valve body.
- Use ONLY grooved-end, NPS carbon steel pipe with Victaulic Butterfly Valves. DO NOT use plain-end NPS pipe or grooved cast ductile iron pipe.
- To prevent valves from rotating in the system, Victaulic recommends installing butterfly valves with at least one Victaulic rigid coupling. If two Victaulic flexible couplings are used, additional support may be required to prevent the valve from rotating. Refer to the instructions, supplied with the couplings and butterfly valves, for proper installation.

JOB/OWNER

System No. _____

Location _____

CONTRACTOR

Submitted By _____

Date _____

ENGINEER

Spec Sect _____ Para _____

Approved _____

Date _____

www.victaulic.com

VICTAULIC IS A REGISTERED TRADEMARK OF VICTAULIC COMPANY. © 2012 VICTAULIC COMPANY. ALL RIGHTS RESERVED.

REV_F



Series W709 AGS Butterfly Valves

150 psi/1035 kPa

MATERIAL SPECIFICATIONS

Body: Ductile iron conforming to ASTM A-536, grade 65-45-12, fusion bonded epoxy coated.

Disc: Ductile iron conforming to ASTM A-536, grade 65-45-12 fusion bonded epoxy coated.

Seat: 300 Series stainless steel

Disc/Seal*:

- **Grade “E” EPDM**

EPDM (Green color code). Temperature range -20°F to 180°F/-29°C to 82°C. Recommended for cold and hot water service within the specified temperature range plus a variety of dilute acids, oil-free air and many chemical services. NOT RECOMMENDED FOR PETROLEUM SERVICES.

* Services listed are General Service Recommendations only. It should be noted that there are services for which these gaskets are not recommended. Reference should always be made to the latest Victaulic Gasket Selection Guide for specific gasket service recommendations and for a listing of services which are not recommended.

Stem–Upper/Lower: 400 Series stainless steel

Bearing: Aluminum bronze

Thrust Washer: Bronze

Stem Seals: EPDM

Gasket Retaining Segment: 300 Series stainless steel

Seal Retaining Screw: 300 Series stainless steel

This product shall be manufactured by Victaulic or to Victaulic specifications. All products to be installed in accordance with current Victaulic installation/assembly instructions. Victaulic reserves the right to change product specifications, designs and standard equipment without notice and without incurring obligations.

Series W709 AGS Butterfly Valves

150 psi/1035 kPa

DIMENSIONS

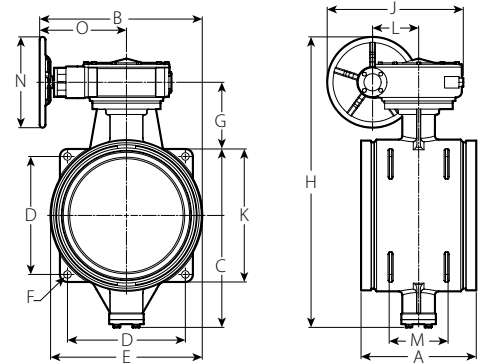

Size	Pressure	Dimensions – inches/mm														Weight
Nominal Size inches mm	psi/kPa	A End to End	B	C	D	E	F	G	H	J	K	L	M	N	O	lbs./kg.
26 650	150 1035	20.00 508	29.25 743	20.13 511	20.50 520	26.38 670	0.88 22	22.38 569	50.38 1280	24.38 619	22.88 581	7.38 187	8.75 222	15.75 400	15.88 403	860.0 390.0
28 700	150 1035	20.00 508	30.25 768	21.00 535	22.00 560	28.38 721	0.88 22	23.63 600	52.63 1337	24.38 619	24.88 632	7.38 187	8.75 222	15.75 400	15.88 403	1023.0 464.0
30 750	150 1035	22.00 559	33.38 848	22.63 575	23.63 600	30.38 772	1.13 29	26.38 670	54.38 1381	28.25 718	26.88 683	9.38 238	9.88 251	15.75 400	18.13 461	1301.0 590.0
32 800	150 1035	22.00 559	35.38 899	24.63 624	25.25 641	32.38 822	1.25 32	27.75 705	58.38 1483	28.25 718	28.38 721	9.38 238	9.88 251	15.75 400	19.38 492	1649.0 748.0
36 900	150 1035	22.00 559	38.63 981	27.38 696	28.38 721	36.38 924	1.25 32	31.88 810	67.13 1705	33.00 838	31.50 800	11.75 298	9.88 251	15.75 400	20.50 520	2161.0 980.0
40 1000	150 1035	24.00 610	44.63 1134	29.50 750	33.50 850	45.00 1144	1.25 32	34.38 873	71.88 1826	33.00 838	37.38 950	11.75 298	10.25 260	15.75 400	22.00 558	3153.0 1430.0
42 1050	150 1035	24.00 610	45.50 1155	31.25 794	35.38 899	47.00 1194	1.38 35	36.00 914	75.00 1906	33.00 838	39.38 1000	11.75 298	10.38 264	15.75 400	22.00 558	3431.0 1556.0
46 1150	150 1035	26.00 660	50.88 1292	33.75 857	37.88 962	51.00 1296	1.50 38	39.88 1013	81.50 2069	41.75 1060	42.50 1080	16.13 410	12.63 321	15.75 400	25.38 645	4476.0 2030.0
48 1200	150 1035	26.00 660	51.88 1318	34.75 883	38.63 981	53.13 1350	1.38 35	40.88 1038	83.38 2118	41.75 1060	44.13 1121	16.13 410	12.63 321	15.75 400	25.38 645	4730.0 2145.0

FLOW CHARACTERISTICS

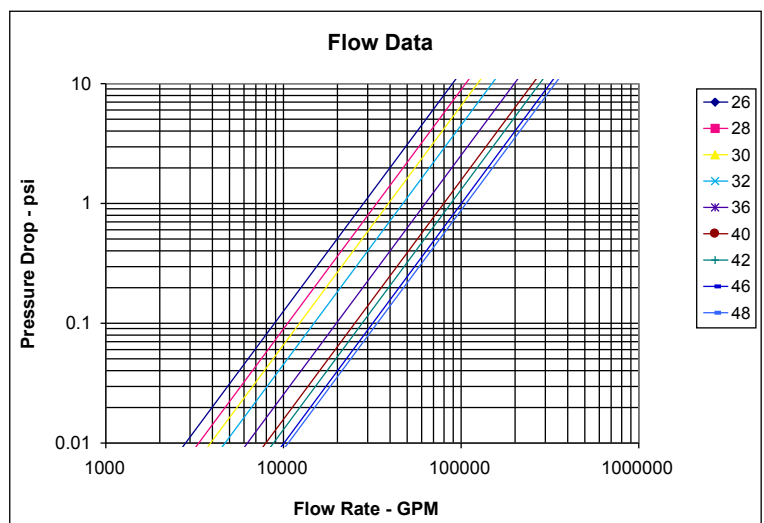

Series W709 AGS Butterfly Valves

150 psi/1035 kPa







PERFORMANCE

C_v values for flow of water at +60°F/+16°C with various disc positions are shown in the table below. Some of the following values are estimated. For exact values, please contact Victaulic for details.

$$\Delta P = \frac{Q^2}{C_v^2}$$

$$Q = C_v \times \sqrt{\Delta P}$$

Where:
 Q = Flow (GPM)
 ΔP = Pressure Drop (psi)
 C_v = Flow Coefficient

Size	C _v at Opening Position						
	C _v Value K _v Value						
	30° 	40° 	50° 	60° 	70° 	80° 	90° 
26 650	3430 2967	5880 5086	9050 7828	11730 10146	17940 15518	26270 22724	28070 24281
28 700	3830 3313	6160 5328	9770 8451	13580 11747	20930 18104	30790 26633	33560 29029
30 750	4220 3650	6450 5579	10500 9083	15430 13347	23900 20674	35230 30474	38960 33700
32 800	4490 3884	7050 6098	11460 9913	17420 15068	27670 23935	41410 35820	46910 40577
36 900	5010 4334	8250 7136	13400 11591	21390 18502	35130 30387	53560 46329	62600 54149
40 1000	7010 6064	12800 11072	19970 17274	28460 24618	45380 39254	68260 59045	79470 68742
42 1050	8020 6937	15070 13036	23270 20129	31990 27671	50460 43648	75490 65299	87700 75861
46 1150	10350 8953	17210 14887	26200 22663	37530 32463	57650 49867	84570 73153	100130 86612
48 1200	11520 9965	18280 15812	27660 23926	40290 34851	61230 52964	89080 77054	106240 91898

Torque Values

Size	Breakaway Torque with Valve Seat Downstream of Pressure (in. lb. / N. m.)			
	Differential Pressure psi/Bar			
	0	50	100	150
26 650	8500 960	20000 2180	34500 3400	46000 5020
28 700	20150 2280	31600 3500	46650 4720	58100 6340
30 750	31800 3590	43100 4810	58800 6030	70100 7660
32 800	43400 4910	54600 6130	71000 7350	82200 8980
36 900	66700 7540	77700 8760	95400 9980	106400 11620
40 1000	90000 10170	100700 11400	119700 12620	130500 14250
42 1050	101650 11480	112300 12710	131900 13940	142600 15570
46 1150	124900 14120	135400 15340	156300 16570	166700 18210
48 1200	136600 15430	147000 16660	168400 17890	178800 19530

Size	Breakaway Torque with Valve Seat Upstream of Pressure (in. lb. / N. m.)			
	Differential Pressure psi/Bar			
	0	50	100	150
26 650	6100 690	14300 1560	24600 2430	32900 3590
28 700	14400 1630	22500 2500	33300 3370	41500 4530
30 750	22700 2570	30800 3430	42000 4310	50100 5470
32 800	31000 3510	39000 4380	50700 5250	58800 6410
36 900	47650 5380	55500 6260	68100 7130	76000 8300
40 1000	64300 7260	72000 8140	85500 9010	93200 10180
42 1050	72600 8200	80200 9080	94200 9950	101900 11120
46 1150	89200 10080	96700 10960	111600 11840	119100 13010
48 1200	97600 11020	105000 11900	120300 12780	127700 13950

Series W709 AGS Butterfly Valves

150 psi/1035 kPa

VALVE TORQUE REQUIREMENTS

Source:

These torque values were derived from test data with non-lubricated valves in water at ambient temperatures with EPDM seals. For other material and service conditions, apply a suitable service factor.

Torque Factors:

All torque values are for normal conditions (i.e. the valve is operated at least once a quarter, disc corrosion is expected to be minor, the media is clean and non-abrasive, and the chemical effects upon the elastomer are minor).

Typical fluid torque factors commonly used in the industry are:

Water: 1.0

Material Torque Factors:

"E" = 1.0

Cycling Factor:

Torque will typically increase as the valve is cycled. A factor of 1.5 should be applied for the first 5000 cycles and another 1.5 applied for all additional cycles. The higher number should be used if there are more than one cycle per hour.

Actuation Factor:

There are no actuation safety factors applied. A factor consistent with the consequences of not actuating should be applied. A minimum factor of 1.2 is recommended for directly actuated valves and 1.5 for 3-way assemblies.

Combining Torque Factors:

When multiple torque factors apply, they are combined by multiplying them. Example: For an EPDM seal and a 5000 cycle factor the combined factor would be $1.0 \times (1.5) = 1.5$.

Note:

Under certain high flow conditions, the hydrodynamic torque can exceed the seating torque. Large butterfly valves are not recommended for use in a free discharge condition, such as filling an empty line with fluid at the full rated pressure.

Contact Victaulic for other services.

INSTALLATION

Reference should always be made to the I-100 Victaulic Field Installation Handbook for the product you are installing. Handbooks are included with each shipment of Victaulic products for complete installation and assembly data, and are available in PDF format on our website at www.victaulic.com.

WARRANTY

Refer to the Warranty section of the current Price List or contact Victaulic for details.

NOTE

This product shall be manufactured by Victaulic or to Victaulic specifications. All products to be installed in accordance with current Victaulic installation/assembly instructions. Victaulic reserves the right to change product specifications, designs and standard equipment without notice and without incurring obligations.

For complete contact information, visit www.victaulic.com

20.07 3857 REV F UPDATED 07/2012

VICTAULIC IS A REGISTERED TRADEMARK OF VICTAULIC COMPANY. © 2012 VICTAULIC COMPANY. ALL RIGHTS RESERVED.

20.07

