

Victaulic® Pressure Valves

Series 867-42T, 867-43T, 867-43T-PS



867-42T



867-43T, 867-43T-PS

1.0 PRODUCT DESCRIPTION

Available Sizes:

- 1 ½ – 16"/DN40 – DN400

Function:

- **867-42T:** Pilot Operated, Pressure Reducing Valve
- **867-43T:** Pilot Operated, Pressure Relief Valve
- **867-43T-PS:** Pump Suction, Pressure Control Valve

Maximum Operating Temperature by Material:

- **Standard:** NR - Fabric Reinforced Polyisoprene 122°F/50°C
- **Optional:** Fabric Reinforced Nitrile (Buna-N) 176°F/80°C

End Connections:

- Grooved (OGS)
- Flanged^{1,2}
- Threaded²

Application:

- Fire Protection Pump Rooms
- Floor Control Assemblies

Codes and Requirements:

- NFPA 13
- NFPA 14
- NFPA 20
- NFPA 25

¹ Valves 10"/DN250 – 16"/DN400 are only available with flanged end connections.

² By special order only.

ALWAYS REFER TO ANY NOTIFICATIONS AT THE END OF THIS DOCUMENT REGARDING PRODUCT INSTALLATION, MAINTENANCE OR SUPPORT.

System No.		Location	
Submitted By		Date	

Spec Section		Paragraph	
Approved		Date	

1.1 PRODUCT DESCRIPTION

Available Sizes, Pressure Ratings and Agency Approvals³

Product Configuration	Nominal Size Range inches DN	FM Approval				UL Listed					
		Grooved				Grooved		Flange			
		Class 300		Class 150				Class 300		Class 150	
		Rating psi bar	Pilot Range psi bar	Rating psi bar	Pilot Range psi bar	Rating psi bar	Pilot Range psi bar	Rating psi bar	Pilot Range psi bar	Rating psi bar	Pilot Range psi bar
867-42T ³	1½ – 2, 2½ DN40, DN50, 73 mm	365 25	30 – 175 2 – 12	235 16	30 – 175 2 – 12	365 25	60 – 175 4 – 12	365 25	60 – 175 4 – 12	250 17	60 – 175 4 – 12
	3 – 8 DN80 – DN200	365 25	30 – 175 2 – 12	235 16	30 – 175 2 – 12	365 25	60 – 175 4 – 12	365 25	60 – 175 4 – 12	250 17	60 – 175 4 – 12
	10 ¹ DN250	300 21	30 – 175 2 – 12	235 16	30 – 175 2 – 12	– –	– –	365 25	60 – 175 4 – 12	250 17	60 – 175 4 – 12
	12 – 16 DN300 – DN400	– –	– –	– –	– –	– –	– –	300 21	60 – 175 4 – 12	250 17	60 – 175 4 – 12
867-43T	1½ – 2, 2½ DN40, DN50, 73 mm	365 25	125 – 365 9 – 25	235 16	60 – 235 4 – 16	365 25	125 – 365 9 – 25	365 25	125 – 365 9 – 25	– –	– –
	3 – 8 DN80 – DN200	365 25	125 – 365 9 – 25	235 16	60 – 235 4 – 16	365 25	125 – 365 9 – 25	365 25	125 – 365 9 – 25	– –	– –
	10 ¹ DN250	300 21	125 – 300 9 – 21	235 16	60 – 235 4 – 16	365 25	125 – 365 9 – 25	365 25	125 – 365 9 – 25	– –	– –
867-43T-PS	1½ – 2, 2½ DN40, DN50, 73 mm	365 25	5 – 30 0.3 – 2	235 16	5 – 30 0.3 – 2	– –	– –	– –	– –	– –	– –
	3 – 8 DN80 – DN200	365 25	5 – 30 0.3 – 2	235 16	5 – 30 0.3 – 2	– –	– –	– –	– –	– –	– –
	10 ¹ DN250	300 21	5 – 30 0.3 – 2	235 16	5 – 30 0.3 – 2	– –	– –	– –	– –	– –	– –

¹ Valves 10"/DN250 are only available with flanged end connections.

³ Selecting optional valve body materials may change listing or approval. Contact Victaulic for details.

NOTES

- Max recommended pressure differential: 175 psi/12 Bar when normal inlet operation pressure is below 330 psi/23 Bar
- Max recommended pressure differential: 200 psi/4 Bar when normal inlet operation pressure is above 330 psi/23 Bar

Available Sizes and Manufacturer's Pressure Rating

Product Configuration	Nominal Size Range inches DN	Flange			
		Class 300		Class 150	
		Rating psi bar	Pilot Range psi bar	Rating psi bar	Pilot Range psi bar
867-43T-PS	12 – 16 DN300 – DN400	300	5 – 30	250	5 – 30
		21	0.3 – 2	16	0.3 – 2

2.0 CERTIFICATION/LISTINGS



NOTE

- Refer to Available Sizes/Pressure Ratings Table in section 1.1 for additional details.

3.0 SPECIFICATIONS - MATERIAL

Series 867-42T, 867-43T, 867-43T-PS Body Style

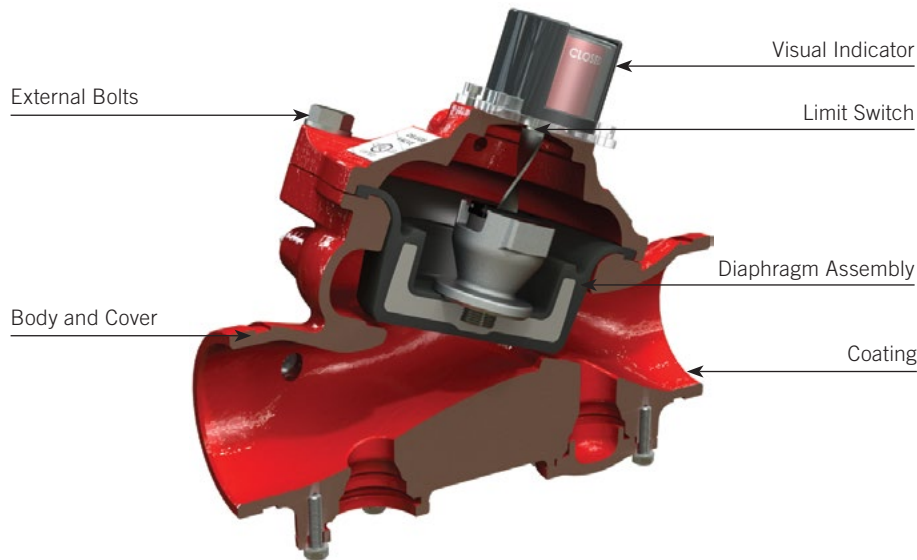

Body and Cover: (specify choice)⁵

- Standard: Ductile Iron ASTM A536 Grade 65-45-12
- Optional: Cast Steel ASTM A216 Grade WCB
- Optional: Stainless Steel 316 ASTM A351 Grade CF8M
- Optional: Nickel Aluminum Bronze ASTM B148, Grade C95800
- Optional: Super Duplex ASTM A890 Grade 5A
- Optional: Hastelloy⁶ ASTM B336 Grade C276
- Optional: Titanium ASTM B367 Grade C2/C3

External Bolts: (specify choice)

- Standard: Stainless steel 316 ASTM A276

Diaphragm Assembly: (specify choice)

- Standard: NR - Fabric Reinforced Polyisoprene
- Optional: Fabric Reinforced Nitrile (Buna-N)

Coating: (specify choice)

- Standard: Electrostatic Powder Coating Polyester
- Optional: High Build Epoxy Fusion-Bonded with UV Protection, Anti-Corrosion

Limit switch double/single: (specify choice)

- Wetted internal parts - AISI 316, Monel⁷, or Hastelloy⁶.

Visual position indicator: (specify choice)

- Wetted internal parts - AISI 316, Monel⁷, or Hastelloy⁶.

⁵ Flanged end connection available in all materials, grooved and threaded available in ductile iron only.

⁶ Hastelloy is a registered trademark of Haynes International.

⁷ Monel is a registered trademark of Special Metals Corporation.

4.0 DIMENSIONS

Series 867-42T, 867-43T, 867-43T-PS

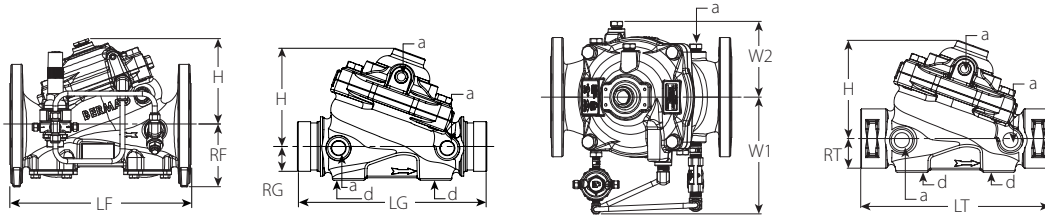

Size		Flanged Class 150						Flanged Class 300					
Nominal	Actual Outside Diameter	LF	RF	H	W ₁	W ₂	Weight	LF	RF	H	W ₁	W ₂	Weight
inches	inches	inches	inches	inches	inches	inches	lb	inches	inches	inches	inches	inches	lb
DN	mm	mm	mm	mm	mm	mm	kg	mm	mm	mm	mm	mm	kg
1 1/2	1.900	9.06	2.56	4.93	6.10	3.05	25.3	9.06	2.56	4.93	6.10	3.05	30.5
DN40	48.3	230	65	125	155	78	11.5	230	65	125	155	78	13.8
2	2.375	9.06	3.03	4.93	6.10	3.05	28.2	9.25	3.03	4.93	6.10	3.05	32.9
DN50	60.3	230	77	125	155	78	12.8	235	77	125	155	78	14.6
2 1/2	2.875	-	-	-	-	-	-	-	-	-	-	-	-
	73.0	-	-	-	-	-	-	-	-	-	-	-	-
3	3.500	12.21	4.18	6.03	9.88	3.94	60.5	12.84	4.18	6.03	9.88	3.94	71.0
DN80	88.9	310	106	153	251	100	27.5	326	106	153	251	100	32.2
4	4.500	13.79	4.77	6.42	10.47	4.53	82.5	14.50	4.77	6.42	10.47	4.53	104.0
DN100	114.3	350	121	163	266	115	37.5	368	121	163	266	115	47.2
6	6.625	18.91	5.79	9.14	14.65	5.51	178.2	19.94	5.79	9.14	14.65	5.51	222.8
DN160	168.3	480	147	232	372	140	81.0	506	147	232	372	140	101.0
8	8.625	23.64	7.09	11.82	19.29	6.77	321.2	24.66	7.09	11.82	19.29	6.77	382.0
DN200	219.1	600	180	300	490	172	146.0	626	180	300	490	172	173.0
10	10.750	28.76	8.04	11.82	19.29	8.03	379.0	28.76	8.04	11.82	19.29	8.03	459.0
DN250	273.0	730	204	300	490	204	172.0	730	204	300	490	204	208.0
12	12.750	33.46	9.72	17.36	25.83	9.53	712.0	28.76	9.72	17.36	25.83	9.53	712.0
DN300	323.9	850	247	441	656	242	323.0	888	247	441	656	242	323.0
14	14.000	38.58	10.71	17.36	25.83	9.53	784.0	38.58	10.71	17.36	25.83	9.53	784.0
DN350	355.6	980	272	441	656	242	356.0	980	272	441	656	242	356.0
16	16.000	43.31	12.44	17.76	25.83	9.53	886.0	43.31	12.44	17.76	25.83	9.53	886.0
DN400	406.4	1100	316	451	656	242	403.0	1100	316	451	656	242	403.0

Size		Grooved						Threaded						All	
Nominal	Actual Outside Diameter	LG	RG	H	W ₁	W ₂	Weight	LT	RT	H	W ₁	W ₂	Weight	a	d
inches	inches	inches	inches	inches	inches	inches	lb	inches	inches	inches	inches	inches	lb	inches	inches
DN	mm	mm	mm	mm	mm	mm	kg	mm	mm	mm	mm	mm	kg	mm	mm
1 1/2	1.900	9.06	0.95	4.93	6.10	3.05	20.2	9.06	0.95	4.93	6.10	3.05	20.2	0.50	0.75
DN40	48.3	230	24	125	155	78	9.2	230	24	125	155	78	9.2	21	27
2	2.375	9.06	1.19	4.93	6.10	3.05	18.7	9.06	1.19	4.93	6.10	3.05	20.3	0.50	0.75
DN50	60.3	230	30	125	155	78	8.5	230	30	125	155	78	9.2	21	27
2 1/2	2.875	9.25	1.44	4.93	6.10	3.05	28.2	-	-	-	-	-	-	0.50	0.75
	73.0	235	37	125	155	78	13.8	-	-	-	-	-	-	21	27
3	3.500	12.21	1.75	6.03	9.88	3.94	36.8	-	-	-	-	-	-	0.50	1.50
DN80	88.9	310	45	153	251	100	16.7	-	-	-	-	-	-	21	48
4	4.500	13.79	2.25	6.42	10.47	4.53	50.3	-	-	-	-	-	-	0.50	2.00
DN100	114.3	350	57	163	266	115	22.8	-	-	-	-	-	-	21	60
6	6.625	18.91	3.31	9.14	14.65	5.51	99.0	-	-	-	-	-	-	0.50	2.00
DN160	168.3	480	84	232	372	140	45.0	-	-	-	-	-	-	21	60
8	8.625	23.64	4.33	11.82	19.29	6.77	262.0	-	-	-	-	-	-	0.50	2.00
DN200	219.1	600	110	300	490	172	119.0	-	-	-	-	-	-	21	60
10	10.750	-	-	-	-	-	-	-	-	-	-	-	-	0.50	2.00
DN250	273	-	-	-	-	-	-	-	-	-	-	-	-	21	60
12	12.750	-	-	-	-	-	-	-	-	-	-	-	-	0.50	2.00
DN300	323.9	-	-	-	-	-	-	-	-	-	-	-	-	21	50
14	14.000	-	-	-	-	-	-	-	-	-	-	-	-	0.50	2.00
DN350	377	-	-	-	-	-	-	-	-	-	-	-	-	21	50
16	16.000	-	-	-	-	-	-	-	-	-	-	-	-	0.50	2.00
DN400	426	-	-	-	-	-	-	-	-	-	-	-	-	21	50

5.0 PERFORMANCE

Relief Valve Sizing

Series 867-42T

Systems must be designed with adequate downstream pressure relief to protect components from over pressurization during pump operation.

To maintain FM Approvals, minimum 1/2"/15mm pressure relief must be provided downstream of all pressure reducing valves.

Flow Chart

Series 867-42T, 867-43T, 867-43T-PS

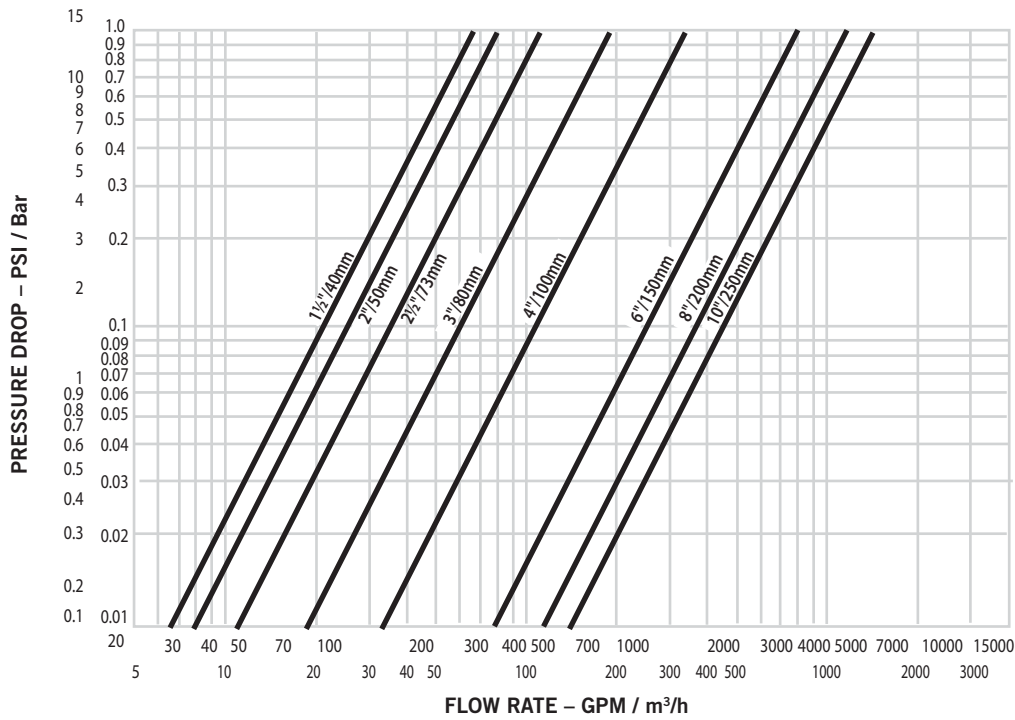

NOTE

- For sizes greater than 10"/DN250, please use information in Section 5.2.

5.0 PERFORMANCE (CONTINUED)

Pressure Control Deluge or Pressure Reducing Valve Pressure Drop Series 867-42T, 867-43T, 867-43T-PS

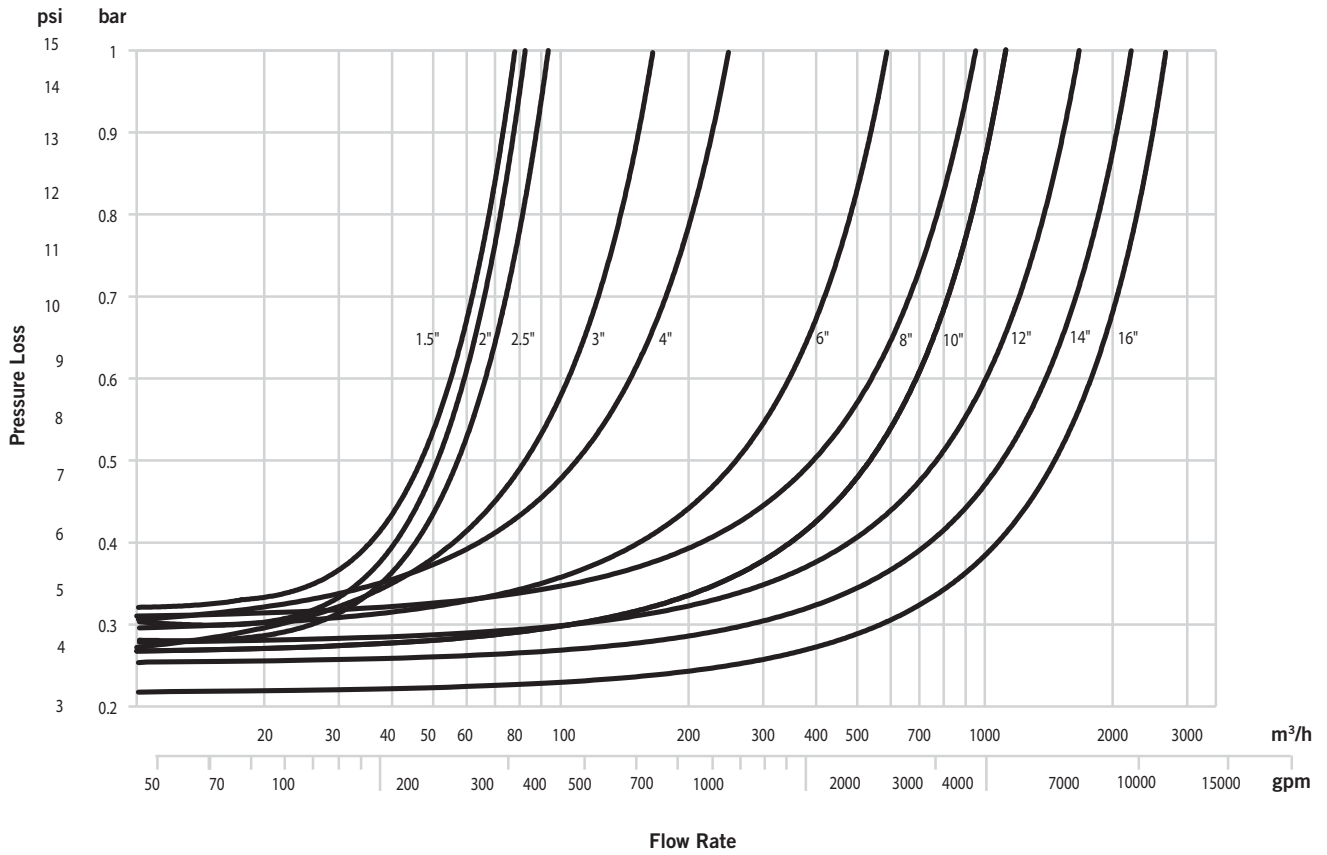

5.1 PERFORMANCE

Must be installed with a minimum of ½" relief valve for FM Approved installations

Discharge Chart Series 867-43T

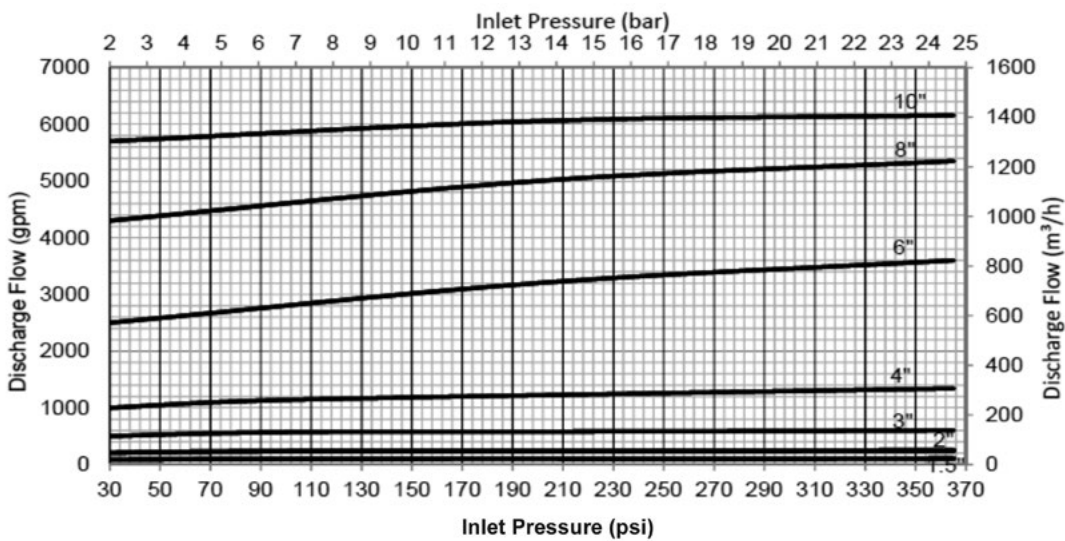

NOTE

- For sizes greater than 10" please use information in Section 5.2.

5.2 PERFORMANCE

Series 867-42T, 867-43T-PS

Cv Values:

Cv values for flow of water at +60°F/+16°C through a fully open valve are shown in the table below.

Formulas for Cv and Kv values

$$\Delta P = \frac{Q^2}{C_v^2} \quad \text{or} \quad \Delta P = \frac{Q^2}{K_v^2}$$

$$Q = C_v \times \sqrt{\Delta P} \quad \quad Q = K_v \times \sqrt{\Delta P}$$

Where:







Flow Coefficient	Cv	Kv
Q (Flow)	GPM	m ³ /hr
ΔP (Pressure Drop)	psi	Bar

Frictional Resistance

The chart below expresses the frictional resistance of Victaulic Series 867-42T, 867-43T, 867-43T-PS Pressure Reducing and Pressure Relief Valves in equivalent feet of straight pipe.

Valve Size		Full Open		Equivalent Length of Pipe feet meters
Nominal inches DN	Actual Outside Diameter inches mm	Flow Coefficient Cv Kv		
1 1/2 DN40	1.900 48.3	79 68		7 2
2 DN50	2.375 60.3	92 80		16 5
2 1/2	2.875 73.0	116 100		28 9
3 DN80	3.500 88.9	219 190		23 7
4 DN100	4.500 114.3	398 345		30 9
6 DN150	6.625 168.3	912 790		49 15
8 DN200	8.625 219.1	1340 1160		89 27
10 DN250	10.750 273.0	1565 1355		203 62
12 DN300	12.750 323.9	2737 2370		171 52
14 DN350	14.000 355.6	3292 2850		194 59
16 DN400	16.000 406.4	3758 3254		289 88

6.0 NOTIFICATIONS

 WARNING	
    	<ul style="list-style-type: none"> • Read and understand all instructions before attempting to install any Victaulic products. • Always verify that the piping system has been completely depressurized and drained immediately prior to installation, removal, adjustment, or maintenance of any Victaulic products. • Wear safety glasses, hardhat, and foot protection. <p>Failure to follow these instructions could result in death or serious personal injury and property damage.</p>
<ul style="list-style-type: none"> • These products shall be used only in fire protection systems that are designed and installed in accordance with current, applicable National Fire Protection Association (NFPA 13, 13D, 13R, etc.) standards, or equivalent standards, and in accordance with applicable building and fire codes. These standards and codes contain important information regarding protection of systems from freezing temperatures, corrosion, mechanical damage, etc. • The installer shall understand the use of this product and why it was specified for the particular application. • The installer shall understand common industry safety standards and potential consequences of improper product installation. • It is the system designer's responsibility to verify suitability of materials for use with the intended fluid media within the piping system and external environment. • The material specifier shall evaluate the effect of chemical composition, pH level, operating temperature, chloride level, oxygen level, and flow rate on materials to confirm system life will be acceptable for the intended service. <p>Failure to follow installation requirements and local and national codes and standards could compromise system integrity or cause system failure, resulting in death or serious personal injury and property damage.</p>	

7.0 REFERENCE MATERIALS

- [10.64: Victaulic Firelock™ Rigid Coupling Style 009N](#)
- [29.01: Victaulic Terms and Conditions](#)
- [I-100: Field Installation Handbook](#)
- [I-009N: Field Installation and Maintenance Style 009N](#)
- [I-867-42T: Installation, Operation and Maintenance Manual Series 867-42T](#)
- [I-867-43T: Installation, Operation and Maintenance Manual Series 867-43T](#)
- [Bermad Fire Protection: Pump Suction Pressure Control Valve Model 43T-PS](#)

User Responsibility for Product Selection and Suitability

Each user bears final responsibility for making a determination as to the suitability of Victaulic products for a particular end-use application, in accordance with industry standards and project specifications, and the applicable building codes and related regulations as well as Victaulic performance, maintenance, safety, and warning instructions. Nothing in this or any other document, nor any verbal recommendation, advice, or opinion from any Victaulic employee, shall be deemed to alter, vary, supersede, or waive any provision of Victaulic Company's standard conditions of sale, installation guide, or this disclaimer.

Intellectual Property Rights

No statement contained herein concerning a possible or suggested use of any material, product, service, or design is intended, or should be construed, to grant any license under any patent or other intellectual property right of Victaulic or any of its subsidiaries or affiliates covering such use or design, or as a recommendation for the use of such material, product, service, or design in the infringement of any patent or other intellectual property right. The terms "Patented" or "Patent Pending" refer to design or utility patents or patent applications for articles and/or methods of use in the United States and/or other countries.

Note

This product shall be manufactured by Victaulic or to Victaulic specifications. All products to be installed in accordance with current Victaulic installation/assembly instructions. Victaulic reserves the right to change product specifications, designs and standard equipment without notice and without incurring obligations.

Installation

Reference should always be made to the Victaulic installation handbook or installation instructions of the product you are installing. Handbooks are included with each shipment of Victaulic products, providing complete installation and assembly data, and are available in PDF format on our website at www.victaulic.com.

Warranty

Refer to the Warranty section of the current Price List or contact Victaulic for details.

Trademarks

Victaulic and all other Victaulic marks are the trademarks or registered trademarks of Victaulic Company, and/or its affiliated entities, in the U.S. and/or other countries.