

FireLock™ V36, K5.6 Models V3605, V3606

Dry Type Pendants Standard and Quick Response



Flush



Sleeve and Skirt



Plain Barrel



Intermediate



Extended



Recessed

1.0 PRODUCT DESCRIPTION

Models: V3606 and V3605

Style: Pendant, Recessed Pendant or Intermediate Level Pendant

Nominal Orifice Size: ½"/13 mm

K-Factor: 5.6 Imp./8.1 S.I.¹

Nominal Thread Size: 1" NPT/25 mm BSPT

Max. Working Pressure: 175 psi/1207 kPa/12 bar

Factory Hydrostatic Test: 100% @ 500 psi/3447 kPa/34 bar

Min. Operating Pressure: 7psi/48 kPa/5 bar

Temperature Rating: See table in section 2.0

¹ For K-Factor when pressure is measured in bar, multiply S.I. units by 10.0.

ALWAYS REFER TO ANY NOTIFICATIONS AT THE END OF THIS DOCUMENT REGARDING PRODUCT INSTALLATION, MAINTENANCE OR SUPPORT.

System No.		Location	
Submitted By		Date	

Spec Section		Paragraph	
Approved		Date	

2.0 CERTIFICATION/LISTINGS



APPROVALS/LISTINGS	Model			
	V3605	V3605	V3606	V3606
Orifice Size (inches)	½	½	½	½
Orifice Size (mm)	13	13	13	13
Nominal K Factor Imperial	5.6	5.6	5.6	5.6
Nominal K Factor S.I. ²	8.1	8.1	8.1	8.1
Response	Standard	Standard	Quick	Quick
Deflector Type	Pendent	Recessed Pendent	Pendent	Recessed Pendent
Approved Temperature Ratings	F°/C°			
cULus	135°F/57°C	135°F/57°C	135°F/57°C	135°F/57°C
	155°F/68°C	155°F/68°C	155°F/68°C	155°F/68°C
	200°F/93°C	200°F/93°C	200°F/93°C	200°F/93°C
	286°F/141°C	286°F/141°C	286°F/141°C	286°F/141°C
FM	135°F/57°C	135°F/57°C	135°F/57°C	135°F/57°C
	155°F/68°C	155°F/68°C	155°F/68°C	155°F/68°C
	200°F/93°C	200°F/93°C	200°F/93°C	200°F/93°C
	286°F/141°C	286°F/141°C	286°F/141°C	286°F/141°C
CCC	155°F/68°C	155°F/68°C	None	None

² For K-Factor when pressure is measured in Bar, multiply S.I. units by 10.

NOTE

- Listings and approval as of printing. Temperatures are listed for all hazards and approved for V3605 and V3606 dry sprinklers up to 48" length.
- CCCf approved for V3605 dry sprinklers 107 to 1250 mm/4.2 - 49.2" in length.

3.0 SPECIFICATIONS – MATERIAL

Deflector: Brass or stainless steel

Bulb: Glass with glycerin solution

Bulb Nominal Diameter:

Standard: 5.0 mm

Quick Response: 3.0 mm

Split Spacer: Stainless steel

Load Screw: Brass

Pip Cap: Stainless steel

Spring Seal Assembly: Teflon™³ coated Beryllium nickel alloy and stainless steel

Frame: Die cast brass

Outer Tube: Galvanized steel pipe

Inner Tube: Stainless steel

Orifice Insert: Stainless steel

Escutcheon/Plate: 1010 - 1018 mild steel and stainless steel

Torsion Spring: SST Wire

Installation Wrench: Model V36 Open End and Recessed Wrenches fit all V36 Series frames.

Sprinkler Finishes:

Plain brass

Chrome plated

White painted^{4, 5}

Flat black painted^{4, 5}

Custom painted^{4, 5}

VC-250⁶

³ Teflon™ is a registered trademark of Dupont Co.

⁴ Not available on the Intermediate Level Style Pendant.

⁵ UL Listed for corrosion resistance.

⁶ UL Listed and FM Approved for corrosion resistance.

NOTE

- Weather resistant escutcheon available upon request.
- For cabinets and other accessories refer to separate sheet.

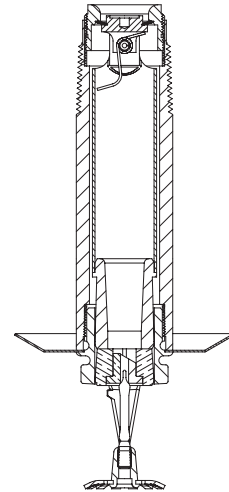

Exaggerated for clarity

4.0 DIMENSIONS

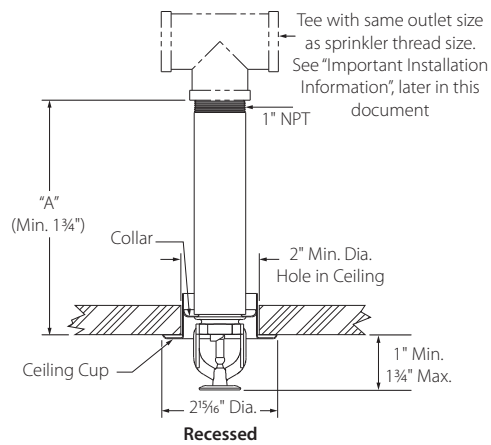
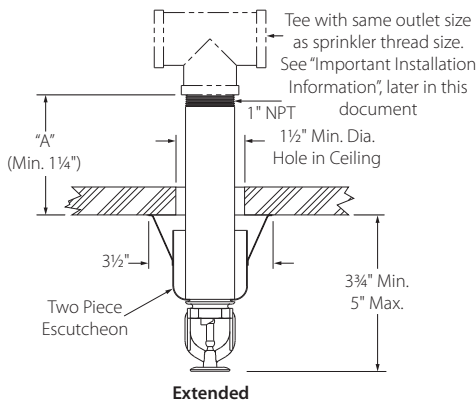
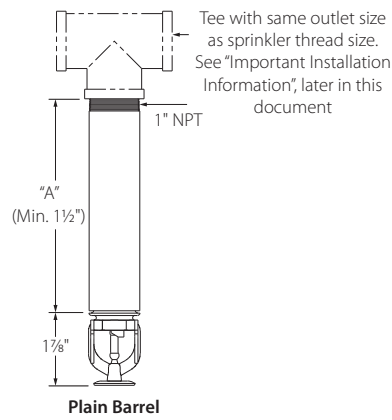
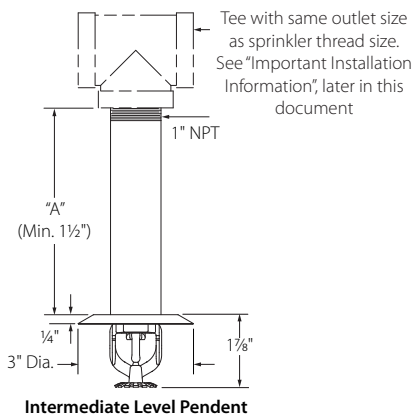
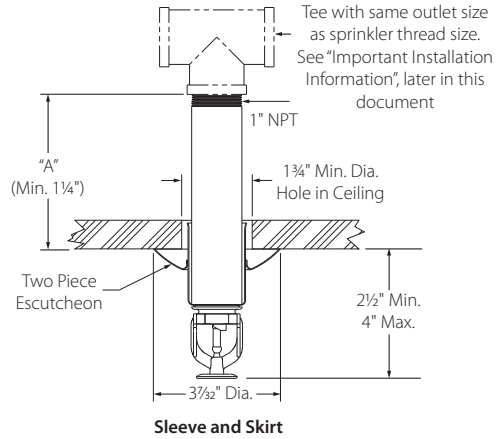
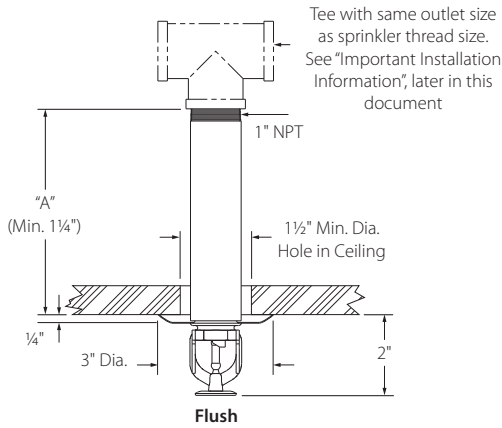



NOTE

- The "A" dimension of a dry sprinkler, which extends into a freezer from a wet piping system, must take into account the wall or ceiling thickness of the freezer. See IMPORTANT INSTALLATION INFORMATION later in this document.

5.0 PERFORMANCE

Contact Victaulic for performance details.

6.0 NOTIFICATIONS

 WARNING	
	<ul style="list-style-type: none">• Read and understand all instructions before attempting to install any Victaulic products.• Always verify that the piping system has been completely depressurized and drained immediately prior to installation, removal, adjustment, or maintenance of any Victaulic products.• Wear safety glasses, hardhat, and foot protection. <p>Failure to follow these instructions could result in death or serious personal injury and property damage.</p>
<ul style="list-style-type: none">• These products shall be used only in fire protection systems that are designed and installed in accordance with current, applicable National Fire Protection Association (NFPA 13, 13D, 13R, etc.) standards, or equivalent standards, and in accordance with applicable building and fire codes. These standards and codes contain important information regarding protection of systems from freezing temperatures, corrosion, mechanical damage, etc.• The installer shall understand the use of this product and why it was specified for the particular application.• The installer shall understand common industry safety standards and potential consequences of improper product installation.• It is the system designer's responsibility to verify suitability of materials for use with the intended fluid media within the piping system and external environment.• The material specifier shall evaluate the effect of chemical composition, pH level, operating temperature, chloride level, oxygen level, and flow rate on materials to confirm system life will be acceptable for the intended service. <p>Failure to follow installation requirements and local and national codes and standards could compromise system integrity or cause system failure, resulting in death or serious personal injury and property damage.</p>	

7.0 REFERENCE MATERIALS

Important Installation Information:

For detailed installation instructions, see [publication I-40](#).

No. 1 Victaulic Model V36 Series Dry sprinklers should be installed in accordance with NFPA 13. These sprinklers are to be installed using a pipe wrench applied to the outer tube. When this is not possible, the proper sprinkler wrench may be used with extreme care for lengths up to approximately 18". Excessive force may distort the frame thus destroying the unit.

No. 2 Dry sprinklers MUST be installed only into the outlet of a cast or malleable iron tee.

No. 3 DO NOT install dry sprinklers into any couplings or threaded elbows. In addition, DO NOT install dry sprinklers into any fitting that interferes with thread penetration. NOTE: The end seal of the dry sprinkler MUST NOT bottom out in the fitting.

TYPICAL SLEEVE AND SKIRT CONFIGURATION FOR EXAMPLE ONLY

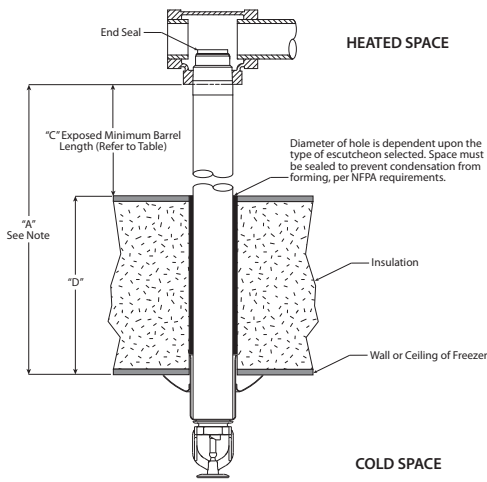

NOTE

- The "A" dimension of a dry sprinkler, which extends into a freezer from a wet piping system, must take into account the wall or ceiling thickness of the freezer. The minimum length of the dry sprinkler should not be less than the lengths specified in the following table, plus the thickness of the freezer's wall or ceiling ("A" = "C" + "D").
- Refer to the drawing for a representation of the "A" dimension. DO NOT attempt to modify dry sprinklers, since they are manufactured to this specific "A" dimension.
- The following table is used when the ambient temperature is maintained between 40°F/4°C and 60°F/16°C around the wet piping system.

Ambient Temperature Exposed to Discharge End of Sprinkler	Exposed Minimum Barrel Length inches/mm		
	40°F 4°C	50°F 10°C	60°F 16°C
40 4	0 0	0 0	0 0
30 -1	0 0	0 0	0 0
20 -7	4 102	0 0	0 0
10 -12	8 203	1 25	0 0
0 -18	12 305	3 76	0 0
-10 -23	14 356	4 102	1 25
-20 -29	14 356	6 152	3 76
-30 -34	16 406	8 203	4 102
-40 -40	18 457	8 203	4 102
-50 -46	20 508	10 254	6 152
-60 -51	20 508	10 254	6 152

7.0 REFERENCE MATERIALS (CONTINUED)

Ratings:

All glass bulbs are rated for temperatures from -67°F/-55°C to those shown in the table below.

Sprinkler Temperature Classification	Temperature		Glass Bulb Color
	Nominal Temperature Rating	Maximum Ambient Temperature Allowed	
	°F °C	°F °C	
Ordinary	135°F 57°C	100°F 38°C	Orange
Ordinary	155°F 68°C	100°F 38°C	Red
Intermediate	200°F 93°C	150°F 65°C	Green
Intermediate	286°F 141°C	225°F 107°C	Blue

Available Wrenches:

Model V36 Open End and Recessed Wrenches fit all V36 Series frames.

7.1 REFERENCE MATERIALS

- [10.65: Victaulic FireLock™ IGS Installation-Ready™ Style V9 Sprinkler Coupling](#)
- [25.14: Victaulic IGS Groove Specifications](#)
- [I-V9: Style V9 Victaulic FireLock™ IGS™ Installation-Ready™ Sprinkler Coupling](#)
- [I-40: Victaulic FireLock™ Automatic Sprinklers Installation and Maintenance Guide](#)

User Responsibility for Product Selection and Suitability

Each user bears final responsibility for making a determination as to the suitability of Victaulic products for a particular end-use application, in accordance with industry standards and project specifications, and the applicable building codes and related regulations as well as Victaulic performance, maintenance, safety, and warning instructions. Nothing in this or any other document, nor any verbal recommendation, advice, or opinion from any Victaulic employee, shall be deemed to alter, vary, supersede, or waive any provision of Victaulic Company's standard conditions of sale, installation guide, or this disclaimer.

Intellectual Property Rights

No statement contained herein concerning a possible or suggested use of any material, product, service, or design is intended, or should be construed, to grant any license under any patent or other intellectual property right of Victaulic or any of its subsidiaries or affiliates covering such use or design, or as a recommendation for the use of such material, product, service, or design in the infringement of any patent or other intellectual property right. The terms "Patented" or "Patent Pending" refer to design or utility patents or patent applications for articles and/or methods of use in the United States and/or other countries.

Note

This product shall be manufactured by Victaulic or to Victaulic specifications. All products to be installed in accordance with current Victaulic installation/assembly instructions. Victaulic reserves the right to change product specifications, designs and standard equipment without notice and without incurring obligations.

Installation

Reference should always be made to the Victaulic installation handbook or installation instructions of the product you are installing. Handbooks are included with each shipment of Victaulic products, providing complete installation and assembly data, and are available in PDF format on our website at www.victaulic.com.

Warranty

Refer to the Warranty section of the current Price List or contact Victaulic for details.

Trademarks

Victaulic and all other Victaulic marks are the trademarks or registered trademarks of Victaulic Company, and/or its affiliated entities, in the U.S. and/or other countries.