

FireLock® V36, K8.0 Models V3607, V3608

**Dry Type Standard Spray Pendant
Intermediate Level Pendant
Recessed Pendant
Standard and Quick Response**



Flush Sleeve and Skirt Plain Barrel Intermediate Extended Recessed

Approvals/Listings:

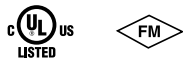

See Victaulic Publication [10.01](#) for more details.

Product Description:

The V36 Dry Sprinkler is used in special applications such as freezing environments and conditions where sediment or foreign materials might accumulate in ordinary drop nipples.

The Models V3608 and V3607 Intermediate Level Pendant sprinklers incorporate a water shield plate to prevent water from higher level sprinklers from interfering with normal operation. These intermediate level sprinklers are designed for use in intermediate levels of rack storage or other open grate storage arrangements, where they may be exposed to upper level or ceiling level sprinklers.

Coverage:

For coverage area and sprinkler placement, refer to NFPA 13 or applicable standards.

Technical Specifications:

Nominal Orifice Size: 17/32"/14 mm

Orifice Insert: Stainless steel per UNS S30300

K-Factor: 8.0 Imp./11.5 S.I.¹

Nominal Thread Size: 1" NPT/33.7 mm

Max. Working Pressure: 175 psi/1200 kPa

Factory Hydrostatic Test: 100% @ 500 psi/3450 kPa

Min. Operating Pressure: 7 psi/48 kPa

Temperature Rating: See chart on page 3

¹ For K-Factor when pressure is measured in Bar, multiply S.I. units by 10.0.

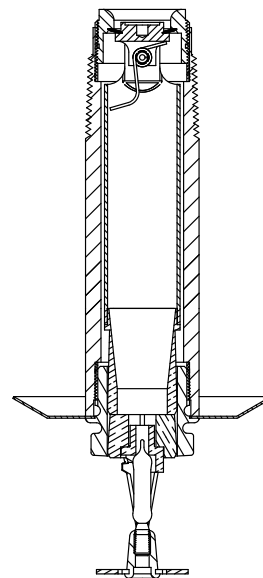

Exaggerated for clarity

Job/Owner

| | |
|------------|--|
| System No. | |
| Location | |

Contractor

| | |
|--------------|--|
| Submitted By | |
| Date | |

Engineer

| | |
|--------------|--|
| Spec Section | |
| Paragraph | |
| Approved | |
| Date | |

Material Specifications:

Deflector: Brass per UNS C22000 or Stainless Steel per UNS S30400

Bulb: Glass with glycerin solution

Standard: 5.0 mm

Quick Response: 3.0 mm

Split Spacer: Stainless steel per UNS S30300

Load Screw: Brass per UNS C36000

Pip Cap: Stainless steel per UNS S30300

Spring Seal Assembly: Teflon² coated Beryllium nickel alloy and stainless steel per UNS S30300

Frame: Die cast brass

Outer Tube: Galvanized steel pipe

Inner Tube: Stainless Steel per UNS S30400

Escutcheon/Plate: 1010 - 1018 mild steel and Stainless Steel

Torsion Spring: SST Wire

Accessories

Installation Wrench: Model V36 Open End and Recessed Wrenches fit all V36 Series frames.

Sprinkler Finishes:

Plain brass

Chrome plated

White painted^{3 4}

Flat black painted^{3 4}

Custom painted^{3 4}

Proprietary Nickel Teflon² Coated⁴

VC-250⁵

155, 200, 286 SR Only:

Wax ⁴

For cabinets and other accessories refer to separate sheet.

² Teflon is a registered trademark of Dupont Co.

³ Not available on the Intermediate Level Style Pendant.

⁴ UL Listed for corrosion resistance.

⁵ UL Listed and FM Approved for corrosion resistance.

Approvals/Listings:

| APPROVALS/LISTINGS | Model | | | |
|-------------------------------------|---|---|---|---|
| | V3608 | V3608 | V3607 | V3607 |
| Orifice Size (inches) | 17/32 | 17/32 | 17/32 | 17/32 |
| Orifice Size (mm) | 14 | 14 | 14 | 14 |
| Nominal K Factor Imperial | 8.0 | 8.0 | 8.0 | 8.0 |
| Nominal K Factor S.I. ⁶ | 11.5 | 11.5 | 11.5 | 11.5 |
| Response | Quick | Quick | Standard | Standard |
| Deflector Type | Pendent | Recessed Pendent | Pendent | Recessed Pendent |
| Approved Temperature Ratings | F°/C° | | | |
| cULus ⁹ | 135°F/57°C 155°F/68°C 200°F/93°C 286°F/141°C | 135°F/57°C 155°F/68°C 200°F/93°C 286°F/141°C | 135°F/57°C 155°F/68°C 200°F/93°C 286°F/141°C | 135°F/57°C 155°F/68°C 200°F/93°C 286°F/141°C |
| FM ⁸ | 135°F/57°C 155°F/68°C 200°F/93°C 286°F/141°C | 135°F/57°C 155°F/68°C 200°F/93°C | 135°F/57°C 155°F/68°C 200°F/93°C 286°F/141°C | 135°F/57°C 155°F/68°C 200°F/93°C |

⁶ For K-Factor when pressure is measured in Bar, multiply S.I. units by 10.

⁸ Approved for V3607 and V3608 dry sprinklers up to 30" length.

⁹ Approved for V3607 and V3608 up to 48" length.

General Notes:

Intermediate Level Pendent is not FM Approved.

Listings and approval as of printing. Temperatures listed for all hazards.

Dimensions:

NOTE: The "A" dimension of a dry sprinkler, which extends into a freezer from a wet piping system, must take into account the wall or ceiling thickness of the freezer. See IMPORTANT INSTALLATION INFORMATION later in this document.

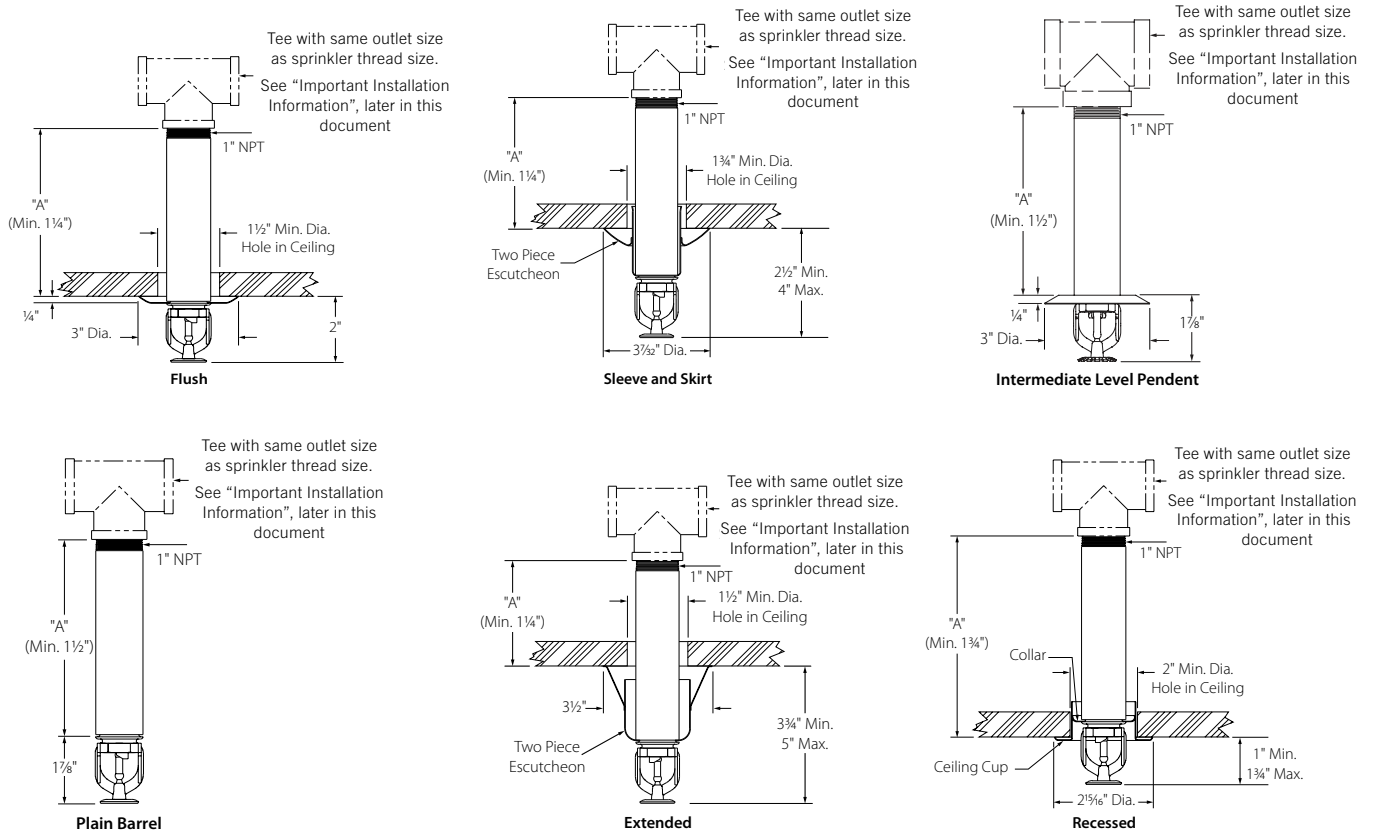

Important Installation Information:

For detailed installation instructions, see publication I-40.

- No. 1 Victaulic Model V36 Series Dry sprinklers should be installed in accordance with NFPA 13. These sprinklers are to be installed using a pipe wrench applied to the outer tube. When this is not possible, the proper sprinkler wrench may be used with extreme care for lengths up to approximately 18". Excessive force may distort the frame thus destroying the unit.
- No. 2 Dry sprinklers MUST be installed only into the outlet of a cast or malleable iron tee.
- No. 3 DO NOT install dry sprinklers into any couplings or threaded elbows. In addition, DO NOT install dry sprinklers into any fitting that interferes with thread penetration. NOTE : The end seal of the dry sprinkler MUST NOT bottom out in the fitting.

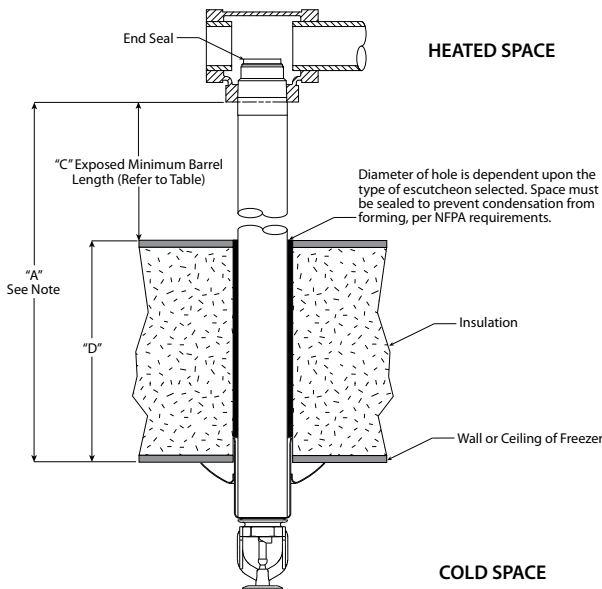

Exaggerated for Clarity

TYPICAL SLEEVE AND SKIRT CONFIGURATION FOR EXAMPLE ONLY

NOTE :

The "A" dimension of a dry sprinkler, which extends into a freezer from a wet piping system, must take into account the wall or ceiling thickness of the freezer. The minimum length of the dry sprinkler should not be less than the lengths specified in the following table, plus the thickness of the freezer's wall or ceiling ("A" = "C" + "D").

Refer to the drawing for a representation of the "A" dimension. DO NOT attempt to modify dry sprinklers, since they are manufactured to this specific "A" dimension.

The following table is used when the ambient temperature is maintained between 40° F/4° C and 60° F/16° C around the wet piping system.

Exposed Barrel Ambient Temperature (°F/°C)

| Ambient Temperature Exposed to Discharge End of Sprinkler °F/°C | Exposed Minimum Barrel Length inches/mm | | |
|---|---|-----------|-----------|
| | 40°F/4°C | 50°F/10°C | 60°F/16°C |
| 40 4 | 0 0 | 0 0 | 0 0 |
| 30 -1 | 0 0 | 0 0 | 0 0 |
| 20 -7 | 4 102 | 0 0 | 0 0 |
| 10 -12 | 8 203 | 1 25 | 0 0 |
| 0 -18 | 12 305 | 3 76 | 0 0 |
| -10 -23 | 14 356 | 4 102 | 1 25 |
| -20 -29 | 14 356 | 6 152 | 3 76 |
| -30 -34 | 16 406 | 8 203 | 4 102 |
| -40 -40 | 18 457 | 8 203 | 4 102 |
| -50 -46 | 20 508 | 10 254 | 6 152 |
| -60 -51 | 20 508 | 10 254 | 6 152 |

Note: Exposed minimum barrel lengths are inclusive up to 30-mph/48-kph wind velocities

Distribution Patterns:

Models V3608, V3607
 Pendent, Recessed Pendent & Intermediate Level Pendent
 Distribution Patterns – Trajectory

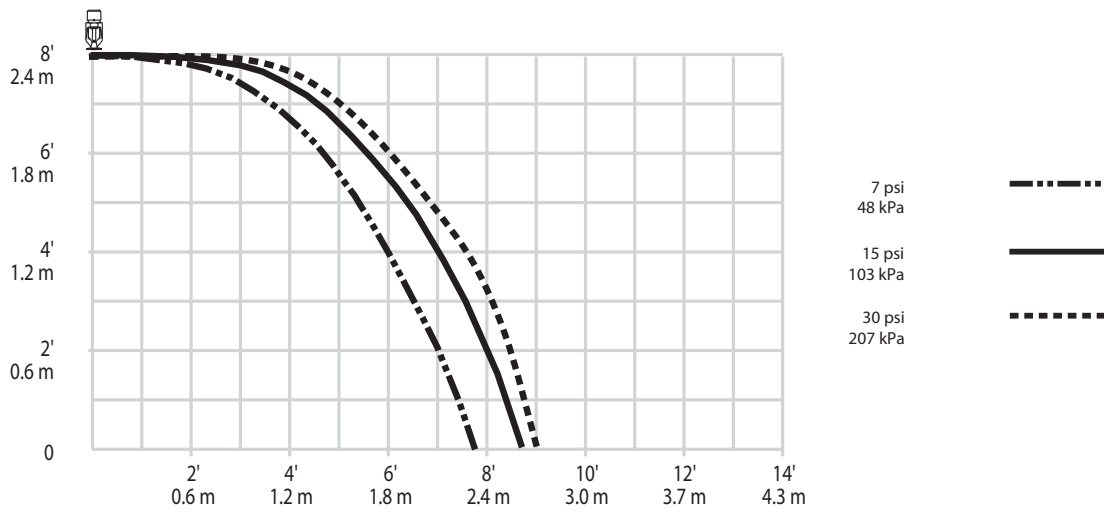

NOTES:

- A. Data shown is approximate and can vary due to differences in installation.
- B. These graphs illustrate approximate trajectories, floor-wetting, and wall-wetting patterns for these specific Victaulic FireLock automatic sprinklers. They are provided as information for guidance in avoiding obstructions to sprinklers and should not be used as minimum sprinkler spacing rules for installation. **Refer to the appropriate NFPA National Fire Code and the Authority Having Jurisdiction for specific information regarding obstructions, spacing limitations and area of coverage requirements.** Failure to follow these guidelines could adversely affect the performance of the sprinkler and will void all Listings, Approvals and Warranties.
- C. All patterns are symmetrical to the centerline of the waterway.

Ratings:



| Sprinkler Temperature Classification | Victaulic Part Identification | Temperature – °F/°C | | Glass Bulb Color |
|--------------------------------------|-------------------------------|----------------------------|-------------------------------------|------------------|
| | | Nominal Temperature Rating | Maximum Ambient Temperature Allowed | |
| Ordinary | A | 135°F/57°C | 100°F/38°C | Orange |
| Ordinary | C | 155°F/68°C | 100°F/38°C | Red |
| Intermediate | E | 175°F/79°C | 150°F/65°C | Yellow |
| Intermediate | F | 200°F/93°C | 150°F/65°C | Green |
| High | J | 286°F/141°C | 225°F /107°C | Blue |
| Extra High | K | 360°F/182°C | 300°F/149°C | Purple |
| – | M | Open | – | No Bulb |

Available Wrenches:

Model V36 Open End and Recessed Wrenches fit all V36 Series frames.



⚠ WARNING

- Always read and understand installation, care, and maintenance instructions, supplied with each box of sprinklers, before proceeding with installation of any sprinklers.
- Always wear safety glasses and foot protection.
- Depressurize and drain the piping system before attempting to install, remove, or adjust any Victaulic piping products.
- Installation rules, especially those governing obstruction, must be strictly followed.
- Painting, plating, or any re-coating of sprinklers (other than that supplied by Victaulic) is not allowed.

Failure to follow these instructions could result in serious personal injury and/or property damage.

The owner is responsible for maintaining the fire protection system and devices in proper operating condition. For minimum maintenance and inspection requirements, refer to the current National Fire Protection Association pamphlet that describes care and maintenance of sprinkler systems. In addition, the authority having jurisdiction may have additional maintenance, testing, and inspection requirements that must be followed.

If you need additional copies of this publication, or if you have any questions about the safe installation of this product, contact Victaulic World Headquarters: P.O. Box 31, Easton, Pennsylvania 18044-0031 USA, Telephone: 001-610-559-3300.

Installation

Reference should always be made to the I-100 Victaulic Field Installation Handbook for the product you are installing. Handbooks are included with each shipment of Victaulic products for complete installation and assembly data, and are available in PDF format on our website at www.victaulic.com.

Warranty

Refer to the Warranty section of the current Price List or contact Victaulic for details.

Note

This product shall be manufactured by Victaulic or to Victaulic specifications. All products to be installed in accordance with current Victaulic installation/assembly instructions. Victaulic reserves the right to change product specifications, designs and standard equipment without notice and without incurring obligations.

Trademarks

Victaulic and Firelock® are registered trademarks of Victaulic Company.