



Vic-Strainer®

SERIES 730 AND **AGS** W730 TEE-TYPE VIC-STRAINERS

SERIES 732 AND **AGS** W732 WYE-TYPE VIC-STRAINERS

IMPORTANT INSTALLATION INFORMATION

⚠ WARNING

- Read and understand all instructions before attempting to install, remove, adjust, or maintain any Victaulic piping products.
- Depressurize and drain the piping system before attempting to install, remove, adjust, or maintain any Victaulic products.
- Wear hardhat, safety glasses, and foot protection.

Failure to follow these instructions could result in serious personal injury, property damage, and/or product damage.

⚠ CAUTION

- To ensure maximum gasket life, make sure the strainer is installed with a gasket grade that is suitable for the intended service.
- Strainer baskets must be cleaned out prior to obtaining 10-psi/ 0.7-Bar/69-kPa pressure differential across the basket.

Failure to follow these instructions could cause joint leakage, resulting in property damage.

The information contained in this instruction sheet must be referenced to ensure proper installation of Series 730/W730 Tee-Type and Series 732/W732 Wye-Type Vic-Strainers.

Series W730 and W732 AGS Vic-Strainers require pipe that is prepared with a grooving technology called the Victaulic Advanced Groove System (AGS). For this reason, special Victaulic AGS (RW) roll sets are required to produce grooves in accordance with AGS specifications. Refer to the Victaulic Field Installation Handbook (I-100) and the operating and maintenance manual for the pipe roll grooving tool for complete information.

NOTE: Maximum service life is dependent upon proper gasket selection and installation. Refer to Victaulic publication 05.01, "Gasket Selection Guide," for details.

ASSEMBLY CLEARANCE

- Select a location for the Vic-Strainer that accommodates the recommended access clearances for removing the strainer basket.

NOTE: Vic-Strainers are shipped fully assembled.

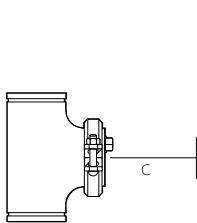

Series 730 Tee-Type Vic-Strainers
Typical 1½ – 12-inch/48.3 – 323.9-mm Sizes

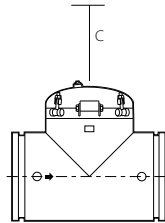

Series 730/W730 Tee-Type Vic-Strainers
Typical 14-inch/355.6-mm and Larger Sizes

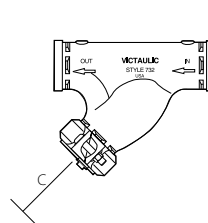

Series 732 Wye-Type Vic-Strainers
Typical 2 – 12-inch/60.3 – 323.9-mm Sizes

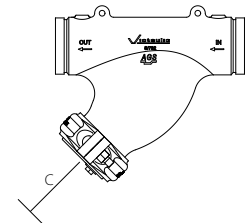

Series 732/W732 Wye-Type Vic-Strainers
Typical 14 – 24-inch/355.6 – 610.0-mm Sizes

MINIMUM CLEARANCE REQUIREMENTS FOR REMOVAL OF SUCTION DIFFUSER BASKETS

Pipe Size		"C" Strainer Basket Minimum Clearance Dimensions inches/mm	
Nominal Diameter inches/mm	Actual Outside Diameter inches/mm	Series 730/W730	Series 732/W732
1½	1.900	4.00	–
40	48.3	102	–
2	2.375	5.00	8.00
50	60.3	127	203
2½	2.875	5.00	9.00
65	73.0	127	229
3	3.500	6.00	10.00
80	88.9	152	254
4	4.500	7.00	12.00
100	114.3	178	305
5	5.563	8.00	14.00
125	141.3	203	356
6	6.625	10.00	16.00
150	168.3	254	406
8	8.625	12.00	20.00
200	219.1	305	508

Pipe Size		"C" Strainer Basket Minimum Clearance Dimensions inches/mm	
Nominal Diameter inches/mm	Actual Outside Diameter inches/mm	Series 730/W730	Series 732/W732
10	10.750	14.00	24.00
250	273.0	356	610
12	12.750	16.00	28.00
300	323.9	406	711
14	14.000	22.00	30.00*
350	355.6	559	762*
16	16.000	23.00	32.00*
400	406.4	584	813*
18	18.000	29.00	35.00*
450	457.0	737	889*
20	20.000	32.00	38.00*
500	508.0	813	965*
24	24.000	37.00	44.00*
600	610.0	940	1118*
30	30.000	44.00	–
750	762.0	1118	–

* These sizes apply only to the Series W732 AGS Vic-Strainer. The Series 732 (non-AGS) Vic-Strainer is not supplied in these sizes.

Vic-Strainer®

SERIES 730 AND **AGS** W730 TEE-TYPE VIC-STRAINERS
 SERIES 732 AND **AGS** W732 WYE-TYPE VIC-STRAINERS

INSTALLATION

NOTICE

- Several of the following steps feature photos of a Series 732 Wye-Type Vic-Strainer. However, the same steps apply to Series W732 AGS Wye-Type Vic-Strainers, Series 730 Tee-Type Vic-Strainers, and Series W730 AGS Tee-Type Vic-Strainers, unless noted otherwise.

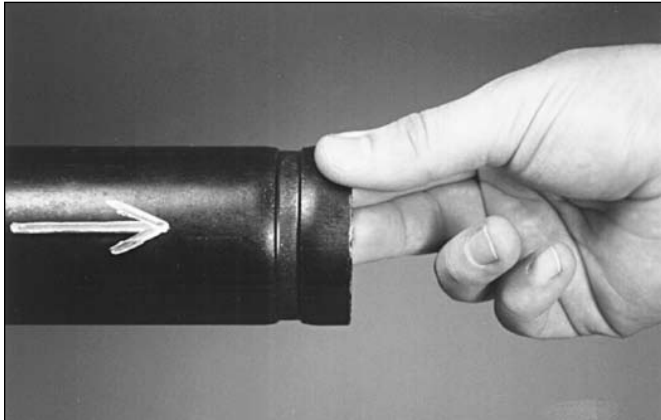

1. **CHECK PIPE ENDS:** The outside surface of the pipe (from the pipe end to the groove) must be smooth and free from indentations, projections (including weld seams), and roll marks to ensure a leak-tight seal. All oil, grease, loose paint, and dirt must be removed. **NOTE:** For W730 and W732 AGS Vic-Strainers, only pipe grooved to AGS specifications must be used for installation. W730 and W732 AGS Vic-Strainers CANNOT be used with pipe that was grooved to non-AGS specifications.

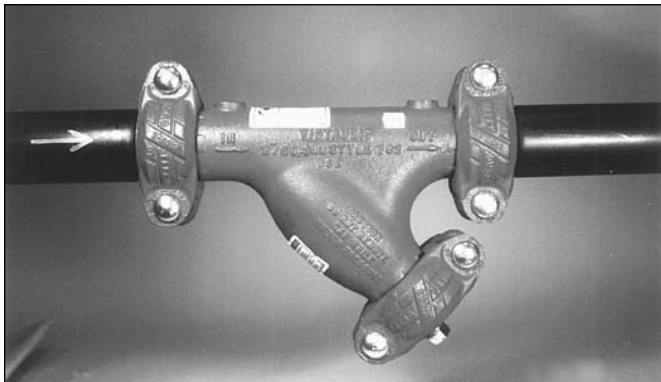

2. **INSTALL VIC-STRAINER:** Align the Vic-Strainer to the piping system so that the flow into and out of the strainer matches the directional arrows cast into the strainer body. Install the Vic-Strainer by using two Victaulic couplings that are suitable for the intended service. Refer to the Victaulic Field Installation Handbook (I-100) for complete coupling installation requirements. **NOTE:** For W730 and W732 AGS Vic-Strainers, only AGS couplings and pipe grooved to AGS specifications must be used for installation. W730 and W732 AGS Vic-Strainers CANNOT be used with non-AGS couplings and/or pipe that was grooved to non-AGS groove specifications.

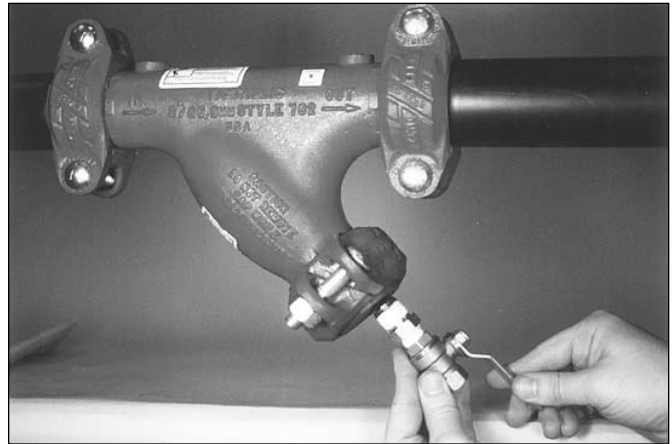

3. **INSTALL BLOW-DOWN PORT:** A blow-down port for connection of a valve with or without drain piping is provided on the access cap. If a valve is installed, make sure it is rated for system conditions.

USING BLOW-DOWN PORT



1. **FLUSH THE STRAINER:** Open the valve that is connected to the blow-down port. This will flush fluid and material from inside the strainer. Close the valve when the strainer basket is flushed sufficiently.

Vic-Strainer®

SERIES 730 AND **AGS** W730 TEE-TYPE VIC-STRAINERS
 SERIES 732 AND **AGS** W732 WYE-TYPE VIC-STRAINERS

MAINTENANCE

⚠ CAUTION

- Strainer baskets must be cleaned out prior to obtaining 10-psi/ 0.7-Bar/69-kPa pressure differential across the basket.

Failure to follow this instruction could cause joint leakage, resulting in property damage.

REMOVAL OF STRAINER BASKET

⚠ WARNING



- Depressurize and drain the piping system before attempting to install, remove, adjust, or maintain any Victaulic piping products.
- The access cap and plug may be under pressure.

Failure to depressurize and drain the piping system could result in serious personal injury, property damage, and/or product damage.



1. REMOVE PIPE PLUG: Make sure the system is depressurized and drained completely. Remove the pipe plug from the access cap or open the blow-down valve to drain the system.



2. REMOVE COUPLING, GASKET, AND ACCESS CAP: While supporting the access cap, loosen the bolts and remove the access coupling. Be prepared to support the strainer basket while removing the gasket and access cap.

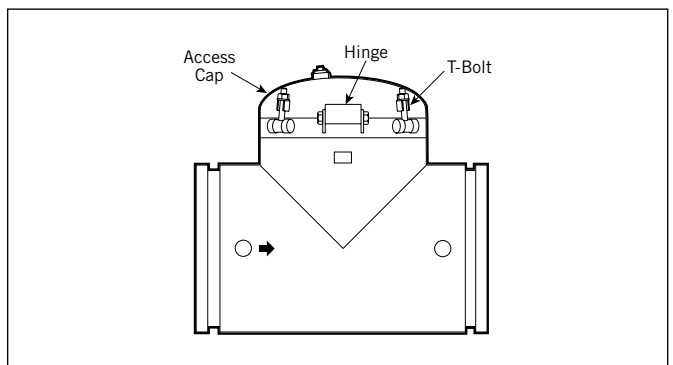

2a. FOR 14 – 30-INCH/355.6 – 762.0-MM SERIES 730 TEE-TYPE VIC-STRAINERS AND 14 – 24-INCH/355.6 – 610.0-MM SERIES W730 AGS TEE-TYPE VIC-STRAINERS: Hinged access caps with T-bolts are standard on these Vic-Strainer sizes. Loosen the nuts on the T-bolts and swing the T-bolts away from the access cap. Open the access cap to remove the strainer basket.

Vic-Strainer®

SERIES 730 AND **AGS** W730 TEE-TYPE VIC-STRAINERS
 SERIES 732 AND **AGS** W732 WYE-TYPE VIC-STRAINERS

SERIES 730/W730

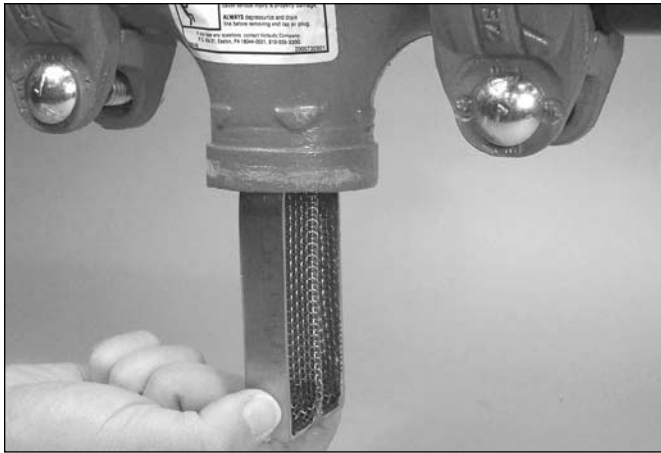

SERIES 732/W732



INSTALLATION OF STRAINER BASKET FOR SERIES 730/W730 TEE-TYPE VIC-STRAINERS

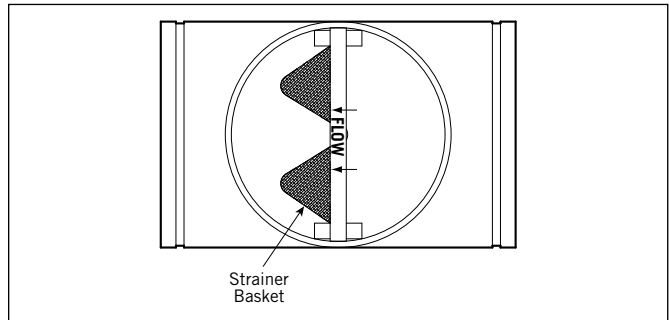

3. **RINSE STRAINER BASKET:** After removing the strainer basket, rinse the basket to remove any debris that has accumulated.

1. **ALIGN STRAINER BASKET:** Align the strainer basket with the slots in the Vic-Strainer body, as shown above. **NOTE:** The rounded portion of the strainer basket must be inserted into the body. Make sure the flow arrow on the Vic-Strainer body points toward the concave (arched inward) side of the strainer basket, as shown in the drawing above.
2. Follow the "Coupling Installation" section.

Vic-Strainer®

SERIES 730 AND **AGS** W730 TEE-TYPE VIC-STRAINERS
 SERIES 732 AND **AGS** W732 WYE-TYPE VIC-STRAINERS

INSTALLATION OF STRAINER BASKET FOR SERIES 732/W732 WYE-TYPE VIC-STRAINERS

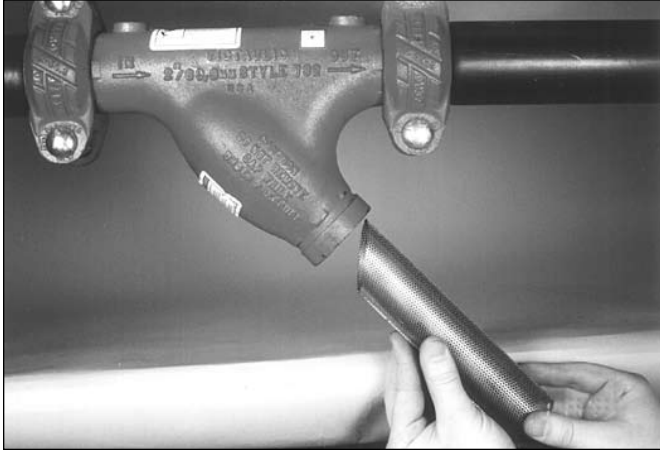

1. **ALIGN STRAINER BASKET:** Align the angled end of the strainer basket for proper insertion into the strainer body, as shown above.

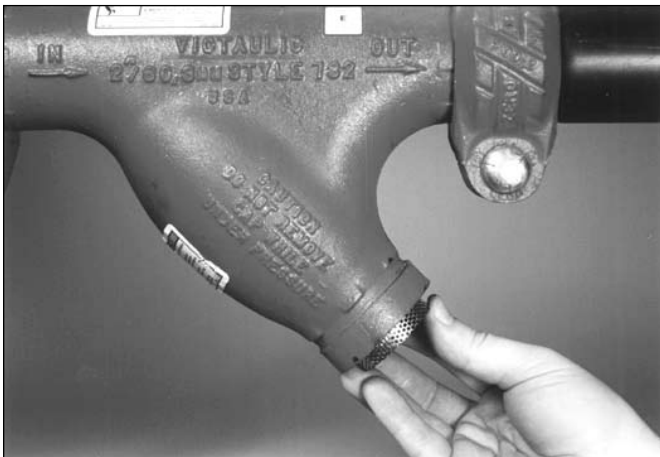

2. **ROTATE THE STRAINER BASKET:** Rotate the strainer basket, if necessary, to keep the amount of protrusion beyond the strainer body to a minimum.
3. Follow the "Coupling Installation" section.

COUPLING INSTALLATION

NOTICE

- The following steps feature photos of a Series 730 Tee-Type Vic-Strainer. However, the same steps apply to Series W730 AGS Tee-Type Vic-Strainers, Series 732 Wye-Type Vic-Strainers, and Series W732 AGS Wye-Type Vic-Strainers, unless noted otherwise.

1. **CHECK GASKET AND LUBRICATE:** Check the gasket for damage or wear. If the gasket is damaged or worn, replace it with a new Victaulic-supplied gasket of the same grade. Apply a thin coat of Victaulic Lubricant or silicone lubricant to the gasket lips and exterior. DO NOT use petroleum-based lubricants on Grade "E" gaskets.



2. **INSTALL ACCESS CAP, GASKET, AND COUPLING:** Install the access cap and gasket onto the Vic-Strainer body. Make sure the gasket is centered between the groove in the Vic-Strainer body and the access cap.
 - 2a. Using the "swing-over" feature, install the housings over the gasket. Make sure the housings' keys engage the groove in the Vic-Strainer body and the outside surface of the access cap.
 - 2b. Install the remaining bolt, and thread the nut onto the bolt until finger-tight. **NOTE:** Make sure the oval neck of the bolts seat properly in the bolt holes.

Vic-Strainer®

SERIES 730 AND **AGS**™ W730 TEE-TYPE VIC-STRAINERS

SERIES 732 AND **AGS**™ W732 WYE-TYPE VIC-STRAINERS

WARNING

- For Victaulic rigid, angle-bolt-pad couplings, the nuts must be tightened evenly by alternating sides until metal-to-metal contact occurs at the bolt pads.
- For Victaulic rigid, angle-bolt-pad couplings, equal offsets must be present at the bolt pads.

Failure to follow these instructions could cause joint failure, resulting in serious personal injury and property damage.

- 2c. Tighten the nuts evenly by alternating sides until metal-to-metal contact occurs at the angle bolt pads. Make sure the housings' keys engage the grooves completely in the suction diffuser body and the end cap. Make sure the offsets are equal at the bolt pads. This is necessary to ensure properly-assembled rigid joint. **NOTE:** It is important to tighten all nuts evenly to prevent gasket pinching.

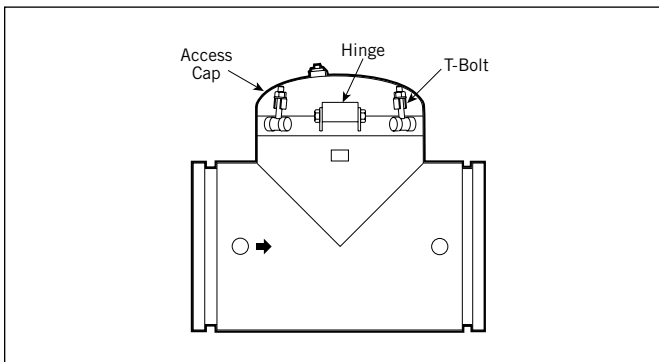

- 2d. **FOR 14 – 30-INCH/355.6 – 762.0-MM SERIES 730 TEE-TYPE VIC-STRAINERS AND 14 – 24-INCH/355.6 – 610.0-MM SERIES W730 AGS TEE-TYPE VIC-STRAINERS:** Close the access cap, engage the T-bolts into the slots on the access cap, and tighten the nuts.

Vic-Strainer®

SERIES 730 AND **AGS** W730 TEE-TYPE VIC-STRAINERS

SERIES 732 AND **AGS** W732 WYE-TYPE VIC-STRAINERS



WCAS-7EPNJE

For complete contact information, visit www.victaulic.com

I-730/732/AGS 3687 REV C UPDATED 05/2008 Z000730732

VICTAULIC IS A REGISTERED TRADEMARK OF VICTAULIC COMPANY. © 2008 VICTAULIC COMPANY. ALL RIGHTS RESERVED. PRINTED IN THE USA.

I-730/732/AGS

