

Victaulic® FireLock Model FL-QR/F

Standard Coverage, Quick Response Flush Pendent Sprinkler, K5.6 (8.1)



40.56



1.0 PRODUCT DESCRIPTION

QUICK RESPONSE FLUSH PENDENT SPRINKLER	
SIN	V2906
Orientation	FLUSH PENDENT
K-Factor ¹	5.6 Imp./8.1 S.I.
Connection	15mm BSPT
Max. Working Pressure	175 psi (1200 kPa)
Escutcheon	FLUSH

AVAILABLE WRENCHES	
SPRINKLER	V29-2 Concealed
Pendent	■

Factory Hydrostatic Test: 100% @ 500 psi/3447 kPa/34 bar

Min. Operating Pressure: CCCf: 7psi/48 kPa/.5 bar

Temperature Rating: See tables in section 2.0

¹ For K-Factor when pressure is measured in bar, multiply S.I. units by 10.0.

2.0 CERTIFICATION/LISTINGS



APPROVALS/LISTINGS	
SIN	V2906
Nominal K Factor Imperial	5.6
Nominal K Factor S.I. ²	8.1
Orientation	Pendent
Escutcheon	Flush
Approved Temperature Ratings F°/C°	
CCC	155°F/68°C
	200°F/93°C
	286°F/141°C

² For K-Factor when pressure is measured in Bar, multiply S.I. units by 10.

NOTE

- Certifications/Listings are current as of printing. For the latest information, please consult the regulatory agency's website.

ALWAYS REFER TO ANY NOTIFICATIONS AT THE END OF THIS DOCUMENT REGARDING PRODUCT INSTALLATION, MAINTENANCE OR SUPPORT.



3.0 SPECIFICATIONS – MATERIAL

- Deflector:** Bronze
- Bulb Nominal Diameter:** 2.5 mm
- Load Screw:** Brass
- Splitter:** Brass
- Spring Seal:** PTFE coated Beryllium nickel alloy
- Frame:** Brass
- Pin:** Stainless steel
- Load Bar:** Bronze
- Level Arm:** Bronze
- Ceiling Cover:** Brass
- Drop Pin Cover:** LDPE
- Installation Wrench:** Steel
- Escutcheon:** Steel (specify choice)
 - Standard: 75mm
 - Optional: 65mm
- Sprinkler Finishes:** White

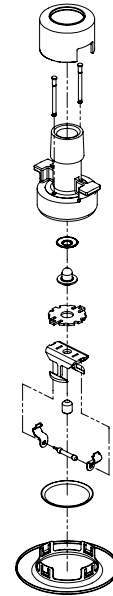

Exaggerated for clarity

4.0 DIMENSIONS



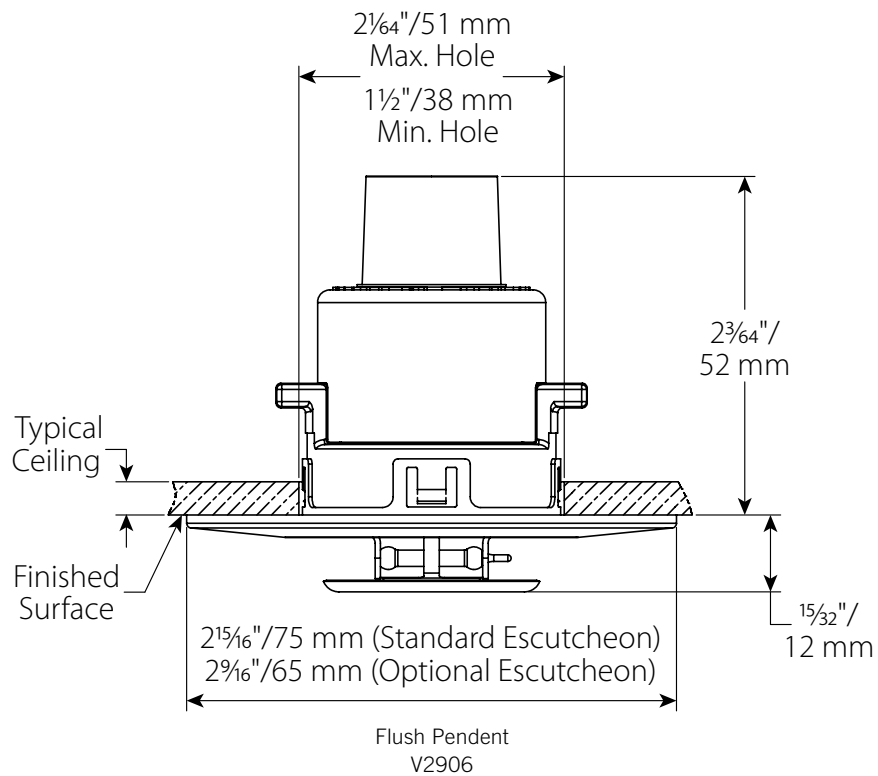



Model V2906



5.0 REFERENCE MATERIALS

Sprinkler is to be installed and designed as per GB50084 and GB50216, or any local standards.

6.0 NOTIFICATIONS

 WARNING	
    	<ul style="list-style-type: none"> • Read and understand all instructions before attempting to install any Victaulic products. • Always verify that the piping system has been completely depressurized and drained immediately prior to installation, removal, adjustment, or maintenance of any Victaulic products. • Wear safety glasses, hardhat, and foot protection. <p>Failure to follow these instructions could result in death or serious personal injury and property damage.</p>
<ul style="list-style-type: none"> • These products shall be used only in fire protection systems that are designed and installed in accordance with current, applicable National Fire Protection Association (NFPA 13, 13D, 13R, etc.) standards, or equivalent standards, and in accordance with applicable building and fire codes. These standards and codes contain important information regarding protection of systems from freezing temperatures, corrosion, mechanical damage, etc. • The installer shall understand the use of this product and why it was specified for the particular application. • The installer shall understand common industry safety standards and potential consequences of improper product installation. • It is the system designer's responsibility to verify suitability of materials for use with the intended fluid media within the piping system and external environment. • The material specifier shall evaluate the effect of chemical composition, pH level, operating temperature, chloride level, oxygen level, and flow rate on materials to confirm system life will be acceptable for the intended service. <p>Failure to follow installation requirements and local and national codes and standards could compromise system integrity or cause system failure, resulting in death or serious personal injury and property damage.</p>	

7.0 REFERENCE MATERIALS

Ratings: All glass bulbs are rated for temperatures from -67°F/-55°C.

[29.01: Victaulic Terms and Conditions of Sales](#)

[I-40: FireLock™ Automatic Sprinklers Installation Manual](#)

User Responsibility for Product Selection and Suitability

Each user bears final responsibility for making a determination as to the suitability of Victaulic products for a particular end-use application, in accordance with industry standards and project specifications, and the applicable building codes and related regulations as well as Victaulic performance, maintenance, safety, and warning instructions. Nothing in this or any other document, nor any verbal recommendation, advice, or opinion from any Victaulic employee, shall be deemed to alter, vary, supersede, or waive any provision of Victaulic Company's standard conditions of sale, installation guide, or this disclaimer.

Intellectual Property Rights

No statement contained herein concerning a possible or suggested use of any material, product, service, or design is intended, or should be construed, to grant any license under any patent or other intellectual property right of Victaulic or any of its subsidiaries or affiliates covering such use or design, or as a recommendation for the use of such material, product, service, or design in the infringement of any patent or other intellectual property right. The terms "Patented" or "Patent Pending" refer to design or utility patents or patent applications for articles and/or methods of use in the United States and/or other countries.

Note

This product shall be manufactured by Victaulic or to Victaulic specifications. All products to be installed in accordance with current Victaulic installation/assembly instructions. Victaulic reserves the right to change product specifications, designs and standard equipment without notice and without incurring obligations.

Installation

Reference should always be made to the Victaulic installation handbook or installation instructions of the product you are installing. Handbooks are included with each shipment of Victaulic products, providing complete installation and assembly data, and are available in PDF format on our website at www.victaulic.com.

Warranty

Refer to the Warranty section of the current Price List or contact Victaulic for details.

Trademarks

Victaulic and all other Victaulic marks are the trademarks or registered trademarks of Victaulic Company, and/or its affiliated entities, in the U.S. and/or other countries.