

# FireLock® V36, K5.6 Models V3601, V3602

## Dry Type Standard Spray Upright Standard and Quick Response



Dry Upright

### Approvals/Listings:

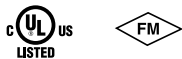

See Victaulic Publication [10.01](#) for more details.

### Product Description:

The Model V36 Series Dry Type Upright Sprinkler has been redesigned utilizing stainless steel internal components. The V36 Dry Sprinkler is used in special applications such as freezing environments. As an example, they may be efficiently used when connected to a wet type sprinkler system and extended into an unheated attic space.

The Model V36 Dry Type Upright Sprinkler utilizes a frangible glass bulb. At the bulb's rated temperature, the sprinkler opens releasing the bulb seat assembly, causing the inner tube assembly to move, allowing the spring assembly to pivot alongside the inner tube. At this time, water flows through the sprinkler and is distributed by the deflector, in the approved discharge pattern.

### Coverage:

For coverage area and sprinkler placement, refer to NFPA 13 or applicable standards.

### Technical Specifications:

**Models:** V3602, V3601

**Style:** Upright

**Nominal Orifice Size:** 1/2"/13 mm

**Orifice Insert:** UNS S30300

**K-Factor:** 5.6 Imp./8.1 S.I.<sup>1</sup>

**Nominal Thread Size:** 1" NPT/33.7 mm

**Max. Working Pressure:** 175 psi/1200 kPa

**Factory Hydrostatic Test:** 100% @ 500 psi/3450 kPa

**Min. Operating Pressure:** 12 psi/83 kPa

**Temperature Rating:** See chart on page 3

<sup>1</sup> For K-Factor when pressure is measured in Bar, multiply S.I. units by 10.0.

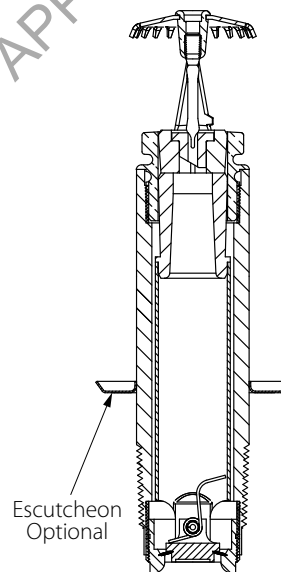

Exaggerated for clarity

### Job/Owner

System No.	
Location	

### Contractor

Submitted By	
Date	

### Engineer

Spec Section	
Paragraph	
Approved	
Date	

---

**Material Specifications:**

**Deflector:** Brass per UNS C22000 or Stainless Steel per UNS S30400

**Bulb:** Glass with glycerin solution

Standard: 5.0 mm

Quick Response: 3.0 mm

**Split Spacer:** Stainless steel per UNS S30300

**Load Screw:** Brass per UNS C36000

**Pip Cap:** Stainless steel per UNS S30300

**Spring Seal Assembly:** Teflon<sup>2</sup> coated Beryllium nickel alloy and stainless steel per UNS S30300

**Frame:** Die cast brass

**Outer Tube:** Galvanized steel pipe

**Inner Tube:** Stainless Steel per UNS S30400

**Torsion Spring:** SST Wire

---

**Accessories**

**Installation Wrench:** Model V36 Open End and Recessed Wrenches fit all V36 Series frames.

**Sprinkler Finishes:**

Plain brass

Chrome plated

White painted<sup>3</sup>

Flat black painted<sup>3</sup>

Custom painted<sup>3</sup>

Proprietary Nickel Teflon<sup>2</sup> Coated<sup>3</sup>

VC-250<sup>4</sup>

**155, 200, 286 SR Only:**

Wax<sup>3</sup>

For cabinets and other accessories refer to separate sheet.

<sup>2</sup> Teflon is a registered trademark of Dupont Co.

<sup>3</sup> UL Listed for corrosion resistance.

<sup>4</sup> UL Listed and FM Approved for corrosion resistance.

DISCONTINUED SUBMITTALS  
REFERENCE <https://www.victaulic.com/assets/uploads/sprinklers>  
FOR OUR CURRENT OFFERING AND APPLICABLE SUBMITTALS

**Approvals/Listings:**

APPROVALS/LISTINGS	Model	
	V3602	V3601
Orifice Size (inches)	1/2	1/2
Orifice Size (mm)	13	13
Nominal K Factor Imperial	5.6	5.6
Nominal K Factor S.I. <sup>5</sup>	8.1	8.1
Response	Quick	Standard
Deflector Type	Upright	Upright
<b>Approved Temperature Ratings</b>	<b>F°/C°</b>	
cULus	135°F/57°C	135°F/57°C
	155°F/68°C	155°F/68°C
	200°F/93°C	200°F/93°C
	286°F/141°C	286°F/141°C
FM	135°F/57°C	135°F/57°C
	155°F/68°C	155°F/68°C
	200°F/93°C	200°F/93°C
	286°F/141°C	286°F/141°C

<sup>5</sup> For K-Factor when pressure is measured in Bar, multiply S.I. units by 10.

Note: Listings and approval as of printing. Temperatures listed for all hazards and approved for V3601 and V3602 dry sprinklers up to 48" length.

**Dimensions:**

The "B" dimension of a dry sprinkler, which extends into a freezer from a wet piping system, must take into account the wall or ceiling thickness of the freezer. See IMPORTANT INSTALLATION INFORMATION later in this document.

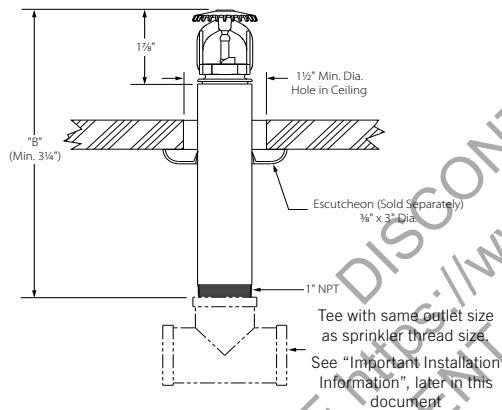

**Important Installation Information:**

**For detailed installation instructions, see publication I-40.**

- No. 1 Victaulic Model V36 Series Dry sprinklers should be installed in accordance with NFPA 13. These sprinklers are to be installed using a pipe wrench applied to the outer tube. When this is not possible, the proper sprinkler wrench may be used with extreme care for lengths up to approximately 18". Excessive force may distort the frame thus destroying the unit.
- No. 2 Dry sprinklers MUST be installed only into the outlet of a cast or malleable iron tee.
- No. 3 DO NOT install dry sprinklers into any couplings or threaded elbows. In addition, DO NOT install dry sprinklers into any fitting that interferes with thread penetration. NOTE : The end seal of the dry sprinkler MUST NOT bottom out in the fitting.

NOTE :

The "A" dimension of a dry sprinkler, which extends into a freezer from a wet piping system, must take into account the wall or ceiling thickness of the freezer. The minimum length of the dry sprinkler should not be less than the lengths specified in the following table, plus the thickness of the freezer's wall or ceiling ("A" = "C" + "D").

Refer to the drawing for a representation of the "A" dimension. DO NOT attempt to modify dry sprinklers, since they are manufactured to this specific "A" dimension.

The following table is used when the ambient temperature is maintained between 40°F/4°C and 60°F/16°C around the wet piping system.

**Exposed Barrel Ambient Temperature (°F/°C)**

Ambient Temperature Exposed to Discharge End of Sprinkler °F/°C	Exposed Minimum Barrel Length inches/mm		
	40°F/4°C	50°F/10°C	60°F/16°C
40	0	0	0
4	0	0	0
30	0	0	0
-1	0	0	0
20	4	0	0
-7	102	0	0
10	8	1	0
-12	203	25	0
0	12	3	0
-18	305	76	0
-10	14	4	1
-23	356	102	25
-20	14	6	3
-29	356	152	76
-30	16	8	4
-34	406	203	102
-40	18	8	4
-40	457	203	102
-50	20	10	6
-46	508	254	152
-60	20	10	6
-51	508	254	152

Note: Exposed minimum barrel lengths are inclusive up to 30-mph/48-kph wind velocities

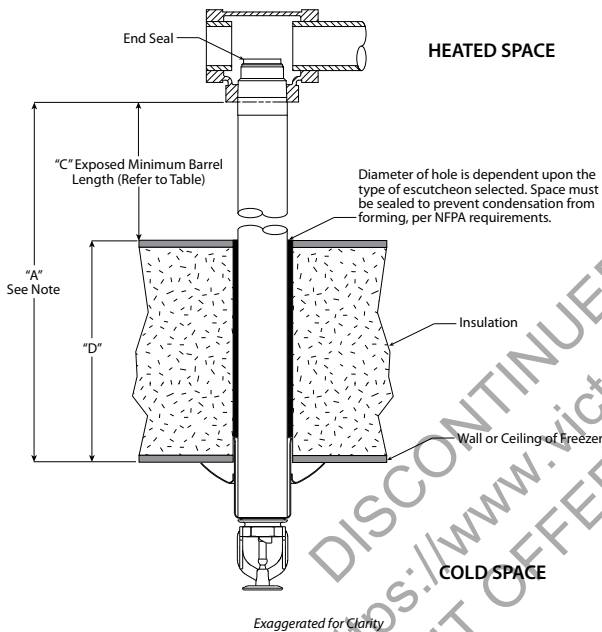

TYPICAL SLEEVE AND SKIRT CONFIGURATION FOR EXAMPLE ONLY

**Distribution Patterns:**

Models V3602, V3601  
Upright Distribution Patterns – Trajectory

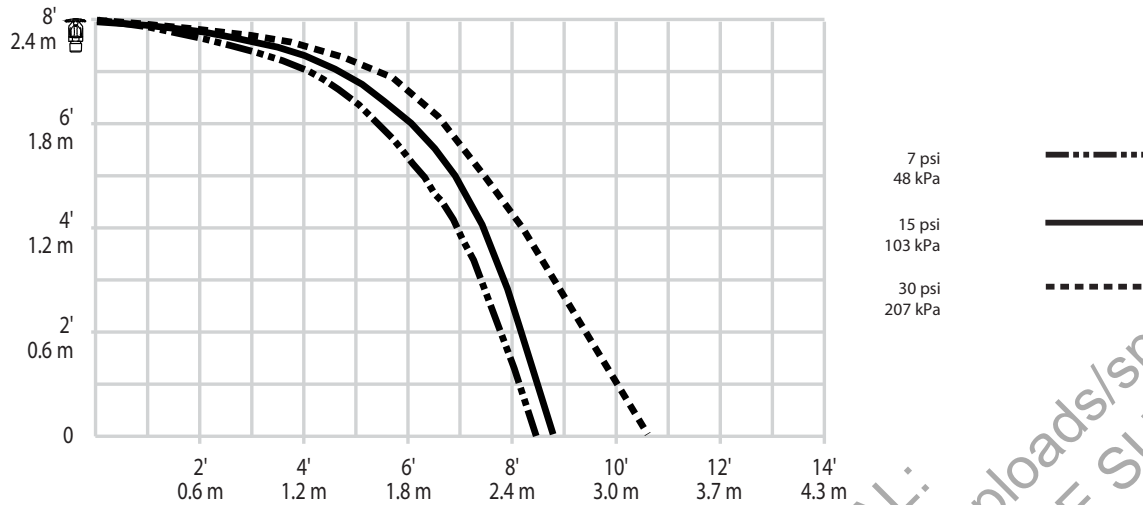

NOTES:

- A. Data shown is approximate and can vary due to differences in installation.
- B. These graphs illustrate approximate trajectories, floor-wetting, and wall-wetting patterns for these specific Victaulic FireLock automatic sprinklers. They are provided as information for guidance in avoiding obstructions to sprinklers and should not be used as minimum sprinkler spacing rules for installation. **Refer to the appropriate NFPA National Fire Code and the Authority Having Jurisdiction for specific information regarding obstructions, spacing limitations and area of coverage requirements.** Failure to follow these guidelines could adversely affect the performance of the sprinkler and will void all Listings, Approvals and Warranties.
- C. All patterns are symmetrical to the centerline of the waterway.

DISCONTINUED SUBMITTAL:  
REFERENCE <https://www.victaulic.com/assets/uploads/sprinklers>  
FOR OUR CURRENT OFFERING AND APPLICABLE SUBMITTALS

**Ratings:**

All glass bulbs are rated for temperatures from -67°F/-55°C to those shown in table below.



Sprinkler Temperature Classification	Victaulic Part Identification	Temperature – °F/°C		Glass Bulb Color
		Nominal Temperature Rating	Maximum Ambient Temperature Allowed	
Ordinary	A	135°F/57°C	100°F/38°C	Orange
Ordinary	C	155°F/68°C	100°F/38°C	Red
Intermediate	E	175°F/79°C	150°F/65°C	Yellow
Intermediate	F	200°F/93°C	150°F/65°C	Green
High	J	286°F/141°C	225°F <sup>8</sup> /107°C	Blue
Extra High <sup>7</sup>	K	360°F/182°C	300°F/149°C	Purple
-	M	Open	-	No Bulb

**Available Wrenches:**

Model V36 Open End and Recessed Wrenches fit all V36 Series frames.



**⚠ WARNING**

- Always read and understand installation, care, and maintenance instructions, supplied with each box of sprinklers, before proceeding with installation of any sprinklers.
- Always wear safety glasses and foot protection.
- Depressurize and drain the piping system before attempting to install, remove, or adjust any Victaulic piping products.
- Installation rules, especially those governing obstruction, must be strictly followed.
- Painting, plating, or any re-coating of sprinklers (other than that supplied by Victaulic) is not allowed.

Failure to follow these instructions could result in serious personal injury and/or property damage.

The owner is responsible for maintaining the fire protection system and devices in proper operating condition. For minimum maintenance and inspection requirements, refer to the current National Fire Protection Association pamphlet that describes care and maintenance of sprinkler systems. In addition, the authority having jurisdiction may have additional maintenance, testing, and inspection requirements that must be followed.

If you need additional copies of this publication, or if you have any questions about the safe installation of this product, contact Victaulic World Headquarters: P.O. Box 31, Easton, Pennsylvania 18044-0031 USA, Telephone: 001-610-559-3300.

**Installation**

Reference should always be made to the I-100 Victaulic Field Installation Handbook for the product you are installing. Handbooks are included with each shipment of Victaulic products for complete installation and assembly data, and are available in PDF format on our website at [www.victaulic.com](http://www.victaulic.com).

**Warranty**

Refer to the Warranty section of the current Price List or contact Victaulic for details.

**Note**

This product shall be manufactured by Victaulic or to Victaulic specifications. All products to be installed in accordance with current Victaulic installation/assembly instructions. Victaulic reserves the right to change product specifications and standard equipment without notice and without incurring obligations.

**Trademarks**

Victaulic and Firelock® are registered trademarks of Victaulic Company.